

Service
Service
Service

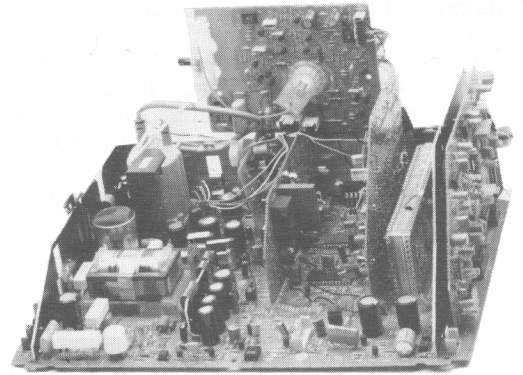

Applicable to sets with serial numbers AG00

39 012 A

Service Manual

TECHNICAL DATA

Mains voltage : 220-240 V ~ ($\pm 10\%$)
 Aerial input impedance : 75 Ω - coax
 Minimum aerial input VHF : 30 μ V
 Minimum aerial input UHF : 40 μ V
 Maximum aerial input : 180 mV

Pull-in range colour sync : +300 Hz/-300 Hz
 Pull-in range horizontal sync : +600 Hz/-600 Hz
 Pull-in range vertical sync : +5 Hz/-5 Hz
 Picture tube range : 24/27 inch 110° flat-square
 : 21 inch 90° flat square

CONTENTS

| | Page | | Page |
|-------------------------------------|-------------|-------------------------------|-------------|
| Technical data | 1 | Diagram C | 11 |
| Warnings | 2 | Stereo decoder | 12+13 |
| Remarks | 2 | PAL decoder | 14+15 |
| Mechanical instructions | 3 | PAL/SECAM decoder | 16+17 |
| Electrical instructions | 3+4 | Remote control RC5336 | 17 |
| Electrical parts list | 5 | TXT decoder | 18+19 |
| Wiring diagram | 6 | | 20+21 |
| Diagram A | 7 | Faultdiagnosis control system | 22 |
| Print lay out control panel | 7 | Symbols for faultfinding | 22 |
| Diagram B | 8 | | |
| Print lay out main panel | 9+10 | | |
| Print lay out picture tube panel | 9+10 | | |
| Print lay out synchronisation panel | 9+10 | | |
| Print lay out headphone panel | 10 | | |

2.

WARNINGS

1. Safety regulations demand that the set be restored to its original condition and that components identical to the original types be used.
Safety components are marked by the symbol \triangle .
2. In order to preclude damage to IC's and transistors flashover of the EHT should be avoided.
For checking the EHT, use a suitable measuring instrument.
The picture tube should only be discharged in the manner shown in Fig. 1.

3. A set to be repaired should always be connected to the mains via a suitable isolating transformer.
4. Proceed with care when testing the EHT section and the picture tube.
5. Never replace any modules or other parts while the set is switched on.
6. Wear safety goggles during replacement of the picture tube.
7. Use plastic instead of metal alignment tools.
This is in order to preclude short-circuits or to prevent a specific circuit from being rendered unstable.

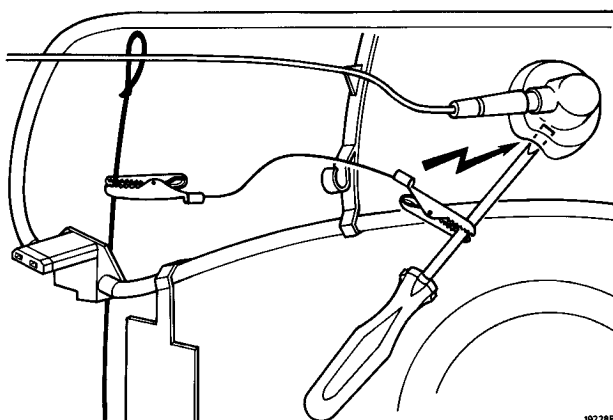

Fig. 1

REMARKS

1. The direct voltages and waveforms should be measured relative to the nearest earthing point on the p.c. board.
2. The direct voltages should be measured as follows:
Apply an aerial signal and adjust receiver for minimum brightness, maximum saturation and contrast.
3. The waveforms should be measured under the following conditions:
 - a. Use a colour-bar pattern as input signal.
 - b. Connect an oscilloscope (0,1 V/div.-DC) to point 5 of TDA4580 (item 7300) via an 10:1 attenuator probe.
 - c. Set the saturation control to obtain 3 V d.c. on point 16 of TDA4580 (item 7300).

- d. Set the brightness control so that the level of the black bar in the video signal is situated at 3 V (see Fig. 2).
 - e. Set the contrast control for a video signal amplitude of 2,8 V.
4. The CRT board is provided with printed spark gaps. Each spark gap is arranged between an electrode of the CRT and the aquadag coating.
 5. During manufacture alternative semi-conductors may be used.
However the semi-conductors specified in the parts list and circuit diagram can always be used as replacements.
 6. Connectors used for the modules (board to board) have been gold-plated and must be replaced by the same type only.



38 864 A12

Fig. 2

Service
Service
Service

Version 2

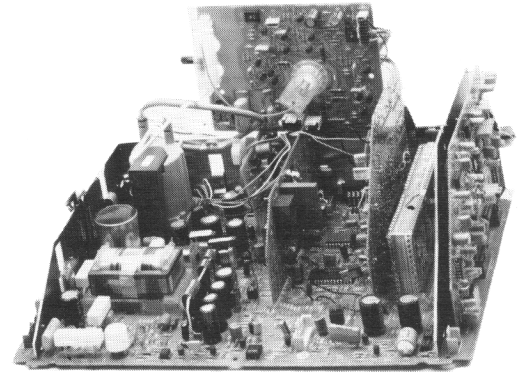

Applicable to sets with serial numbers AG02 and higher

39 012 A

Service Manual

TECHNICAL DATA

Mains voltage : 220-240 V ~ (± 10%)
 Aerial input impedance : 75 Ω - coax
 Minimum aerial input VHF : 30 μV
 Minimum aerial input UHF : 40 μV
 Maximum aerial input : 180 mV

Pull-in range colour sync : +300 Hz/-300 Hz
 Pull-in range horizontal sync : +600 Hz/-600 Hz
 Pull-in range vertical sync : +5 Hz/-5 Hz
 Picture tube range : 24/27 inch 110° flat-square
 : 21 inch 90° flat square

CONTENTS

| | Page |
|----------------------------------|-------------|
| Technical data | 1 |
| Warnings | 2 |
| Remarks | 2 |
| Mechanical instructions | 3 |
| Electrical instructions | 3+4 |
| Electrical parts list | 5 |
| Wiring diagram | 6 |
| Diagram A | 7 |
| Print lay out control panel | 7 |
| Diagram B | 8 |
| Print lay out main panel | 9+10 |
| Print lay out picture tube panel | 9+10 |
| Print lay out auxiliary panels | 9+10 |
| Print lay out headphone panel | 10 |

| | Page |
|-------------------------------|----------------|
| Diagram C | 11 |
| Stereo decoder | 12+13 |
| PAL decoder | 14+15 |
| PAL/SECAM decoder | 16+17 |
| Remote control RC5336 | 17 |
| TXT decoder | 18+19 20+21 |
| Faultdiagnosis control system | 22 |
| Symbols for faultfinding | 22 |

2.

WARNINGS

1. Safety regulations demand that the set be restored to its original condition and that components identical to the original types be used.
Safety components are marked by the symbol \triangle .
2. In order to preclude damage to IC's and transistors flashover of the EHT should be avoided.
For checking the EHT, use a suitable measuring instrument.
The picture tube should only be discharged in the manner shown in Fig. 1.

3. A set to be repaired should always be connected to the mains via a suitable isolating transformer.
4. Proceed with care when testing the EHT section and the picture tube.
5. Never replace any modules or other parts while the set is switched on.
6. Wear safety goggles during replacement of the picture tube.
7. Use plastic instead of metal alignment tools.
This is in order to preclude short-circuits or to prevent a specific circuit from being rendered unstable.

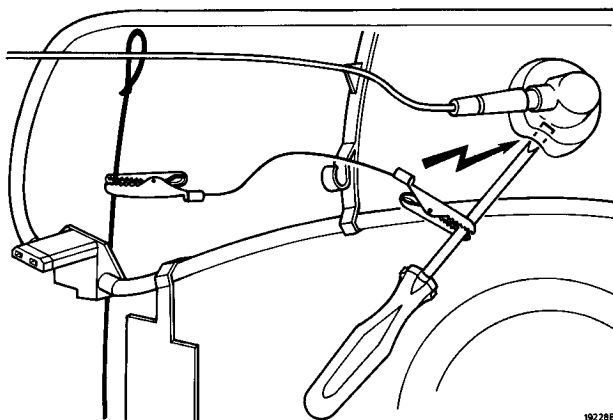
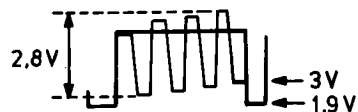

Fig. 1

REMARKS

1. The direct voltages and waveforms should be measured relative to the nearest earthing point on the p.c. board.
2. The direct voltages should be measured as follows:
Apply an aerial signal and adjust receiver for minimum brightness, maximum saturation and contrast.
3. The waveforms should be measured under the following conditions:
 - a. Use a colour-bar pattern as input signal.
 - b. Connect an oscilloscope (0,1 V/div.-DC) to point 5 of TDA4580 (item 7300) via an 10:1 attenuator probe.
 - c. Set the saturation control to obtain 3 V d.c. on point 16 of TDA4580 (item 7300).
 - d. Set the brightness control so that the level of the black bar in the video signal is situated at 3 V (see Fig. 2).
 - e. Set the contrast control for a video signal amplitude of 2,8 V.
4. The CRT board is provided with printed spark gaps. Each spark gap is arranged between an electrode of the CRT and the aquadag coating.
5. During manufacture alternative semi-conductors may be used.
However the semi-conductors specified in the parts list and circuit diagram can always be used as replacements.
6. Connectors used for the modules (board to board) have been gold-plated and must be replaced by the same type only.



38 864 A12

Fig. 2

Service
Service
Service

Version 3

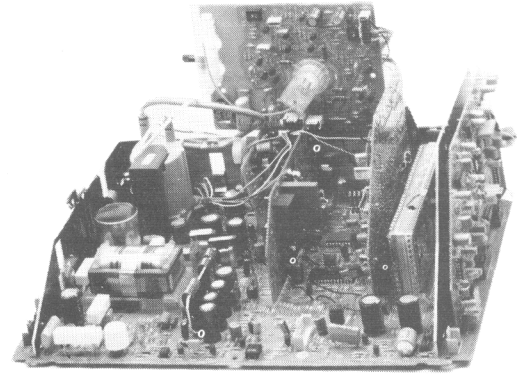

Applicable to sets with serial numbers AG04 and higher

39 012 A

Service Manual

TECHNICAL DATA

| | | | |
|--------------------------|-----------------------|-------------------------------|-------------------------------|
| Mains voltage | : 220-240 V ~ (± 10%) | Pull-in range colour sync | : +300 Hz/-300 Hz |
| Aerial input impedance | : 75 Ω - coax | Pull-in range horizontal sync | : +600 Hz/-600 Hz |
| Minimum aerial input VHF | : 30 μV | Pull-in range vertical sync | : +5 Hz/-5 Hz |
| Minimum aerial input UHF | : 40 μV | Picture tube range | : 24/27 inch 110° flat-square |
| Maximum aerial input | : 180 mV | | : 21 inch 90° flat square |

CONTENTS

| | Page | | Page |
|----------------------------------|-------------|-------------------------------|-------------|
| Technical data | 1 | Diagram C | 11 |
| Warnings | 2 | Stereo decoder | 12+13 |
| Remarks | 2 | PAL decoder | 14+15 |
| Mechanical instructions | 3 | PAL/SECAM decoder | 16+17 |
| Electrical instructions | 3+4 | TXT decoder | 18+19 |
| Electrical parts list | 5 | | 20+21 |
| Wiring diagram | 6 | Faultdiagnosis control system | 23 |
| Diagram A | 7 | Symbols for faultfinding | 24 |
| Print lay out control panel | 7 | | |
| Diagram B | 8 | | |
| Print lay out main panel | 9+10 | | |
| Print lay out picture tube panel | 9+10 | | |
| Print lay out auxiliary panels | 9+10 | | |
| Print lay out headphone panel | 10 | | |

2.

WARNINGS

1. Safety regulations demand that the set be restored to its original condition and that components identical to the original types be used.
Safety components are marked by the symbol ▲.
2. In order to preclude damage to IC's and transistors flashover of the EHT should be avoided.
For checking the EHT, use a suitable measuring instrument.
To prevent damage of the picture tube, the method indicated in Fig. 1 has to be applied when discharging the picture tube.
Make use of a high-voltage probe and a universal meter (position DC-V)
Discharge until the deflection on the meter has become 0 Volt (after about 30 s)

3. ESD



All ICs and many other semi-conductors are susceptible to electrostatic discharges (ESD) Careless handling during repair can reduce life drastically.

When repairing, make sure that you are connected with the same potential as the mass of the set via a wrist wrap with resistance.

Keep components and tools also at this potential.

REMARKS

1. The direct voltages and waveforms should be measured relative to the nearest earthing point on the p.c. board.
2. The direct voltages should be measured as follows:
Apply an aerial signal and adjust receiver for minimum brightness, maximum saturation and contrast.
3. The waveforms should be measured under the following conditions:
 - a. Use a colour-bar pattern as input signal.
 - b. Connect an oscilloscope (0,1 V/div.-DC) to point 5 of TDA4580 (item 7300) via an 10:1 attenuator probe.
 - c. Set the saturation control to obtain 3 V d.c. on point 16 of TDA4580 (item 7300).

4. A set to be repaired should always be connected to the mains via a suitable isolating transformer.
5. Proceed with care when testing the EHT section and the picture tube.
6. Never replace any modules or other parts while the set is switched on.
7. Wear safety goggles during replacement of the picture tube.
8. Use plastic instead of metal alignment tools.
This is in order to preclude short-circuits or to prevent a specific circuit from being rendered unstable.

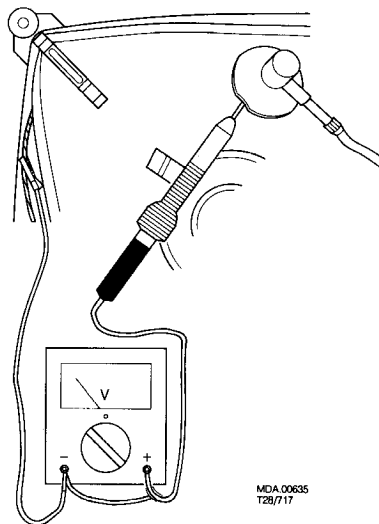

MDA 00635
T28/717

Fig. 1

- d. Set the brightness control so that the level of the black bar in the video signal is situated at 3 V (see Fig. 2).
 - e. Set the contrast control for a video signal amplitude of 2,8 V.
4. The CRT board is provided with printed spark gaps. Each spark gap is arranged between an electrode of the CRT and the aquadag coating.
 5. During manufacture alternative semi-conductors may be used.
However the semi-conductors specified in the parts list and circuit diagram can always be used as replacements.
 6. Connectors used for the modules (board to board) have been gold-plated and must be replaced by the same type only.



38 864 A 12

Fig. 2

Service Manual

| CONTENTS | Page |
|------------------------------------|------|
| Technical data | 1 |
| Warnings | 2 |
| Remarks | 2 |
| Mechanical instructions | 3 |
| Electrical instructions | 3 |
| Wiring diagram | 4 |
| Diagram A | 5 |
| Diagram stereo sound module | 6 |
| Print layout stereo sound module | 7 |
| Diagram NICAM decoder module | 8 |
| Print layout NICAM decoder module | 8 |
| Fault finding tree NICAM | 8 |
| Notes for fault finding tree NICAM | 9 |
| Symbols for faultfinding tree | 10 |
| Survey of connectors | 10 |

TECHNICAL DATA

| | |
|-------------------------------|--|
| Mains voltage | : 220–240 V (10 %) |
| Aerial input impedance | : 75 Ω – coax |
| Minimum aerial input VHF | : 30 μ V |
| Minimum aerial input UHF | : 40 μ V |
| Maximum aerial input | : 180 mV |
| Pull-in range colour sync | : +300 Hz / –300 Hz |
| Pull-in range horizontal sync | : +600 Hz / –600 Hz |
| Pull-in range vertical sync | : +5 Hz / –5 Hz |
| Picture tube range | : 24"/27" 110° flat-square : 21" 90° flat-square |

2.

WARNINGS

1. Safety regulations demand that the set be restored to its original condition and that components identical to the original types be used.
Safety components are marked by the symbol ▲.
2. In order to preclude damage to IC's and transistors flashover of the EHT should be avoided.
For checking the EHT, use a suitable measuring instrument.
To prevent damage of the picture tube, the method indicated in Fig. 1 has to be applied when discharging the picture tube.
Make use of a high-voltage probe and a universal meter (position DC-V)
Discharge until the deflection on the meter has become 0 Volt (after about 30 s)

3. ESD



All ICs and many other semi-conductors are susceptible to electrostatic discharges (ESD) Careless handling during repair can reduce life drastically.

When repairing, make sure that you are connected with the same potential as the mass of the set via a wrist wrap with resistance.

Keep components and tools also at this potential.

REMARKS

1. The direct voltages and waveforms should be measured relative to the nearest earthing point on the p.c. board.
2. The direct voltages should be measured as follows:
Apply an aerial signal and adjust receiver for minimum brightness, maximum saturation and contrast.
3. The waveforms should be measured under the following conditions:
 - a. Use a colour-bar pattern as input signal.
 - b. Connect an oscilloscope (0,1 V/div.-DC) to point 5 of TDA4580 (item 7300) via an 10:1 attenuator probe.
 - c. Set the saturation control to obtain 3 V d.c. on point 16 of TDA4580 (item 7300).

4. A set to be repaired should always be connected to the mains via a suitable isolating transformer.
5. Proceed with care when testing the EHT section and the picture tube.
6. Never replace any modules or other parts while the set is switched on.
7. Wear safety goggles during replacement of the picture tube.
8. Use plastic instead of metal alignment tools.
This is in order to preclude short-circuits or to prevent a specific circuit from being rendered unstable.

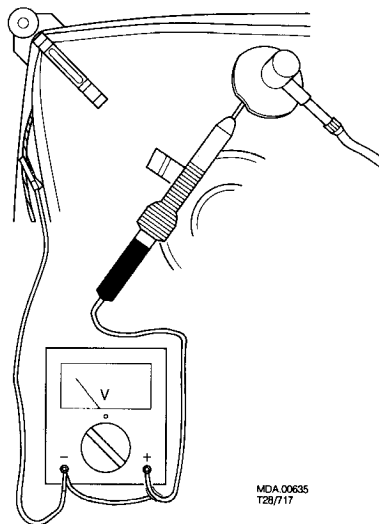
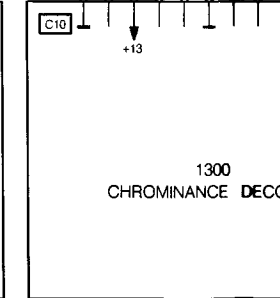
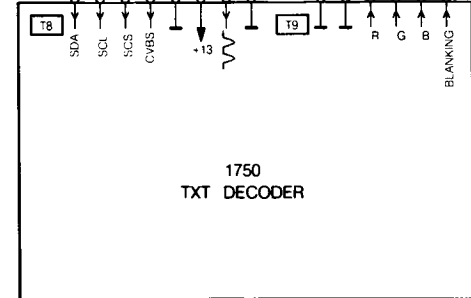
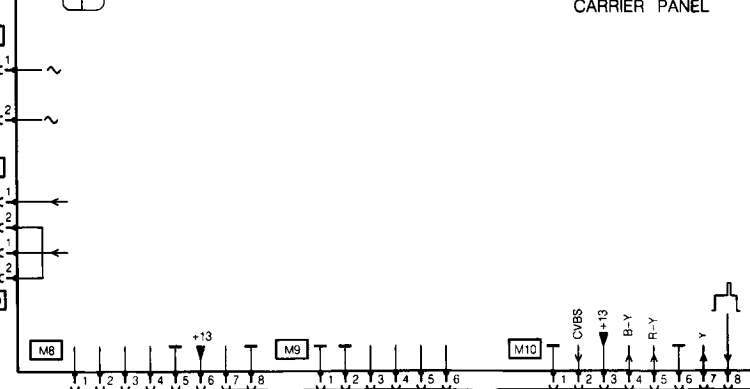
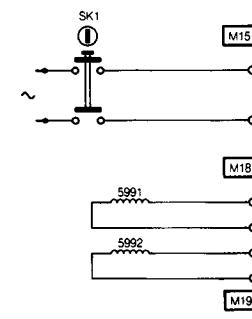
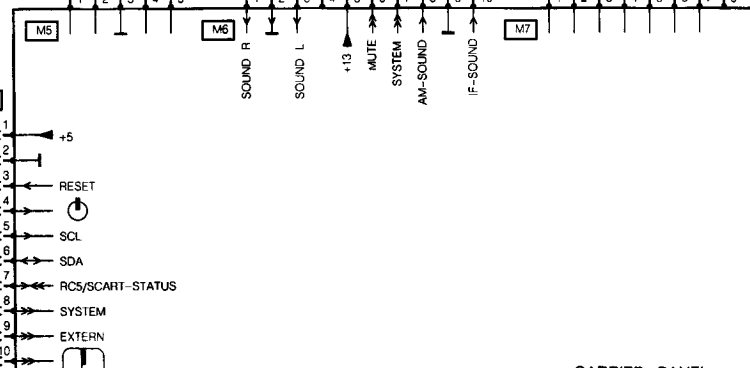
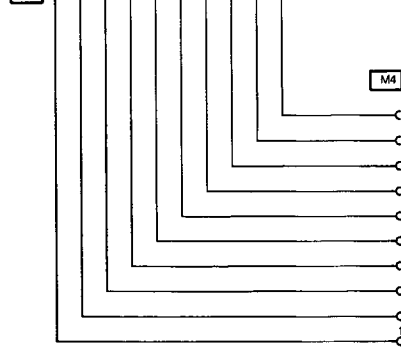
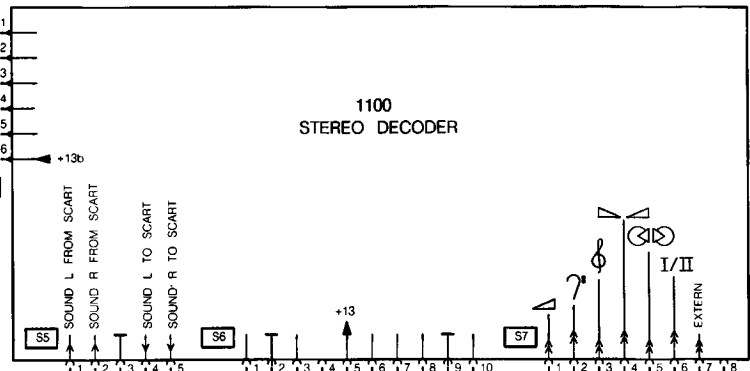
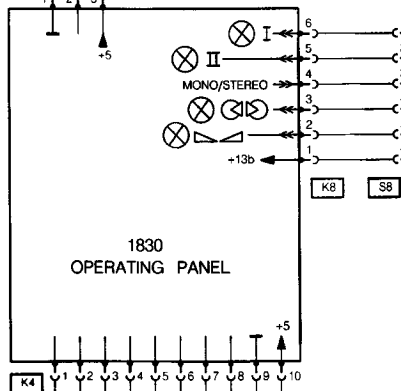
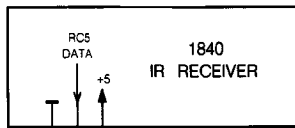

Fig. 1

- d. Set the brightness control so that the level of the black bar in the video signal is situated at 3 V (see Fig. 2).
 - e. Set the contrast control for a video signal amplitude of 2,8 V.
4. The CRT board is provided with printed spark gaps. Each spark gap is arranged between an electrode of the CRT and the aquadag coating.
 5. During manufacture alternative semi-conductors may be used.
However the semi-conductors specified in the parts list and circuit diagram can always be used as replacements.
 6. Connectors used for the modules (board to board) have been gold-plated and must be replaced by the same type only.



Fig. 2



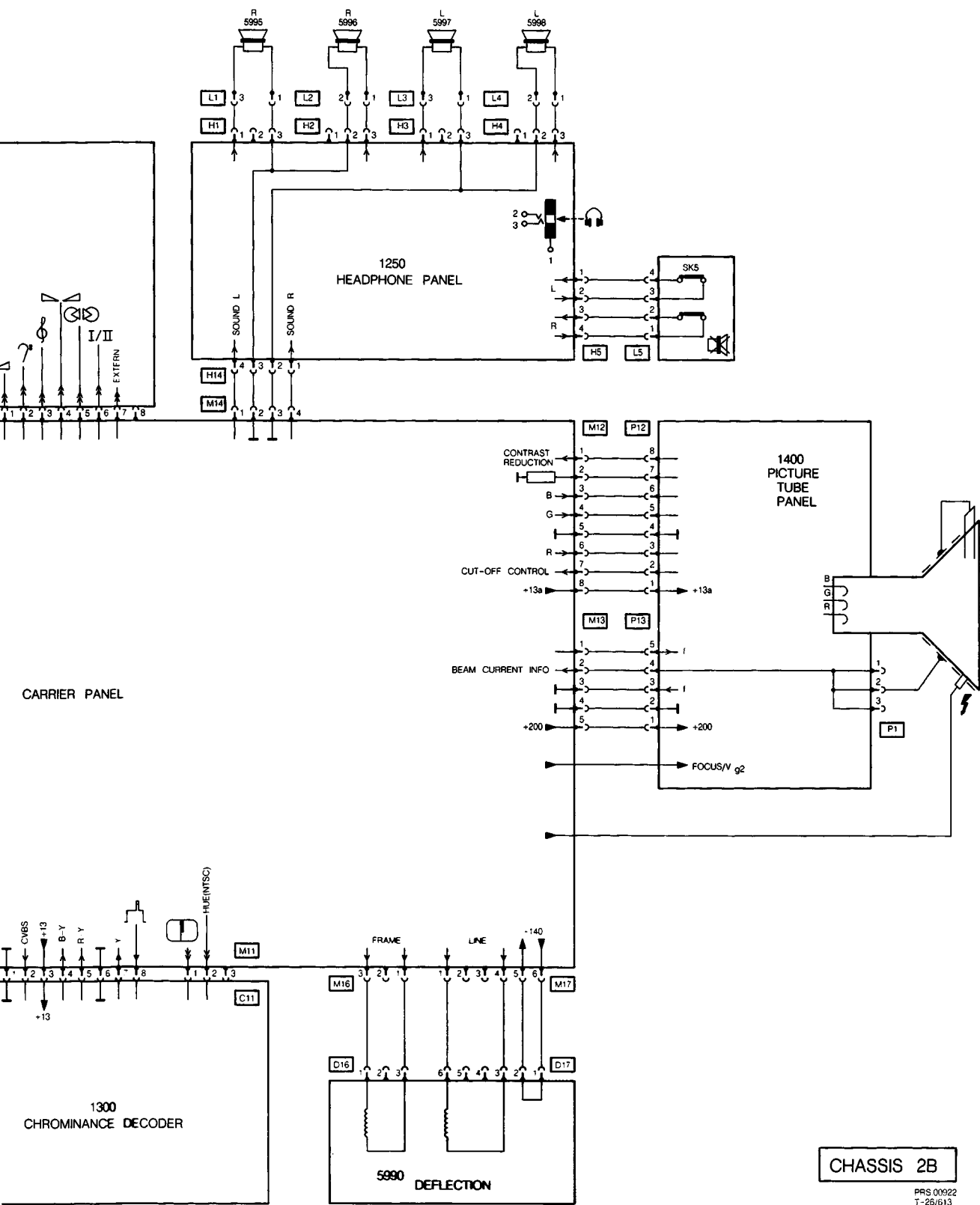

CHASSIS 2B

PRS 00922
T-25/613

CARRIER PANEL



| | | |
|-----------|----------------|---------------|
| CNX62 | 4822 130 90121 | |
| PCD8571P | 4822 209 10427 | |
| SAB3035 | 4822 209 11012 | |
| TDA1520AQ | 4822 209 70223 | (for 2x 15 W) |
| TDA1520BQ | 4822 209 70021 | (for 2x 10 W) |
| TDA3653AQ | 4822 209 83263 | (for 90°) |
| TDA3654Q | 4822 209 83351 | (for 110°) |
| TDA4580 | 4822 209 70018 | |
| TDA8370 | 4822 209 70178 | |



| | | |
|-----------|----------------|--|
| BC369 | 5322 130 44593 | |
| BC547 | 4822 130 44257 | |
| BC548 | 4822 130 40938 | |
| BC548C | 4822 130 44196 | |
| BC556 | 4822 130 40989 | |
| BC557 | 4822 130 44256 | |
| BC558 | 4822 130 40941 | |
| BC558B | 4822 130 44197 | |
| BD234 | 4822 130 40917 | |
| BD826 | 4822 130 41774 | |
| BD943 | 5322 130 44921 | |
| BF819 | 4822 130 42159 | |
| BUT12A | 4822 130 43919 | |
| 2SD1577PV | 4822 130 43921 | |



| | | |
|-------------|----------------|--|
| BAS11 | 4822 130 41273 | |
| BAV21 | 4822 130 30842 | |
| BT151F-500R | 4822 130 20194 | |
| BY228 | 4822 130 41275 | |
| BY229F-200 | 4822 130 33529 | |
| BY229F-600 | 4822 130 33531 | |
| BYD33D | 4822 130 42488 | |
| BYD33G | 4822 130 42489 | |
| BYD33J | 4822 130 42606 | |
| BYV27-150 | 4822 130 31628 | |
| BYW95C | 4822 130 41602 | |
| BZV85-C5V1 | 4822 130 31456 | |
| BZX55-B5V1 | 4822 130 33524 | |
| BZX55-B6V2 | 4822 130 33525 | |
| BZX55-B9V1 | 4822 130 33668 | |
| BZX55-C33 | 4822 130 33684 | |
| BZX79-C2V7 | 5322 130 34563 | |
| BZX79-C3V9 | 4822 130 31981 | |
| BZX79-C4V7 | 4822 130 34174 | |
| BZX79-C12 | 4822 130 34197 | |
| BZX79-C18 | 4822 130 31024 | |
| BZX79-C33 | 4822 130 34142 | |
| BZX79-C47 | 4822 130 34383 | |
| HZ7A3 | 4822 130 33523 | |
| OF705-8V2 | 4822 130 33633 | |
| OF705-30 | 4822 130 32807 | |



| | | |
|--------|----------------|--|
| SF2D41 | 4822 130 20193 | |
| 1N4148 | 4822 130 31438 | |
| 1N5061 | 4822 130 31933 | |



| | | |
|------|----------------|------------------|
| 5027 | 4822 157 50961 | |
| 5555 | 4822 157 52681 | |
| 5567 | 4822 157 50964 | |
| 5601 | 4822 158 10728 | (for 110°) |
| 5601 | 4822 156 21293 | (for 90°) |
| 5611 | 4822 157 52472 | (for 110°) |
| 5611 | 4822 158 10553 | (for 90°) |
| 5612 | 4822 157 52688 | (for 110°) |
| 5612 | 4822 156 21332 | (for 90°) |
| 5619 | 4822 157 52505 | |
| 5620 | 4822 140 10294 | Line output |
| 5632 | 4822 146 10111 | Line driver |
| 5637 | 4822 157 51157 | |
| 5642 | 4822 157 52506 | |
| 5643 | 4822 157 52506 | |
| 5644 | 4822 157 52506 | |
| 5646 | 4822 157 52506 | |
| 5651 | 4822 157 52505 | |
| 5652 | 4822 157 52505 | |
| 5663 | 4822 146 21121 | SOPS transformer |
| 5687 | 4822 156 10769 | |
| 5697 | 4822 157 52407 | |
| 5698 | 4822 157 52407 | |

Various

| | | |
|------|----------------|--|
| 1921 | 4822 242 70668 | Crystal 4 MHz |
| 1925 | 4822 138 10138 | Battery 1,2 V |
| | 4822 267 60172 | SCART socket |
| | 4822 276 11237 | Switch SK2 |
| | 4822 410 24151 | Knob on SK2 |
| | 4822 273 30324 | Switch SK4 |
| | 4822 256 30274 | Fuse holder 1651 |
| | 4822 267 30631 | Socket var. level |
| 1224 | 4822 280 20213 | Relais |
| | 4822 492 41268 | Spring fix. TS7599 |
| | 4822 492 63339 | Spring fix. TS7618 |
| | 4822 492 62907 | Spring fix. other transistors and IC's |
| | 4822 255 40527 | Isolation plates |
| | 4822 320 20097 | EHT cable |
| | 4822 320 20126 | Focus cable long |
| | 4822 320 40136 | Focus cable short |
| | 4822 267 50606 | Connector on focus cable |

CARRIER PANEL



| | | | |
|------|----------------|---------|--------|
| 3023 | 4822 111 30515 | 18 Ω | 0,33 W |
| 3030 | 4822 111 30505 | 7.5 Ω | 0,33 W |
| 3203 | 4822 111 30494 | 2.7 Ω | 0,33 W |
| 3213 | 4822 111 30494 | 2.7 Ω | 0,33 W |
| 3290 | 4822 111 30508 | 10 Ω | 0,33 W |
| 3535 | 4822 111 30508 | 10 Ω | 0,33 W |
| 3542 | 4822 100 20487 | 10 kΩ | potm. |
| 3557 | 5322 116 64011 | 30 MΩ | 0,25 W |
| 3558 | 4822 110 72201 | 3.3 MΩ | 0,25 W |
| 3559 | 4822 100 11022 | 1 MΩ | potm. |
| 3560 | 5322 116 64026 | 6.2 MΩ | 0,25 W |
| 3592 | 4822 116 52302 | 750 kΩ | 0,5 W |
| 3595 | 4822 100 20487 | 10 kΩ | potm. |
| 3602 | 4822 111 30513 | 15 Ω | 0,33 W |
| 3632 | 4822 116 53418 | 2.7 kΩ | 5 W |
| 3632 | 4822 116 53568 | 3.3 kΩ | 5 W |
| 3644 | 4822 111 30483 | 1 Ω | 0,33 W |
| 3645 | 4822 111 30483 | 1 Ω | 0,33 W |
| 3646 | 4822 111 30494 | 2.7 Ω | 0,33 W |
| 3647 | 4822 111 30494 | 2.7 Ω | 0,33 W |
| 3651 | 4822 111 30553 | 470 Ω | 0,33 W |
| 3652 | 4822 111 30553 | 470 Ω | 0,33 W |
| 3653 | 4822 116 40033 | NTC/PTC | (110°) |
| 3653 | 4822 116 40065 | PTC/PTC | (90°) |
| 3654 | 5322 113 41033 | 2.2 Ω | 7 W |
| 3654 | 4822 113 80388 | 3.9 Ω | 7 W |
| 3664 | 4822 113 80383 | 82 Ω | 7 W |
| 3666 | 4822 111 30502 | 5.6 Ω | 0,33 W |
| 3671 | 4822 113 11002 | 15 Ω | 5 W |
| 3678 | 4822 116 52784 | 2.7 kΩ | 0,4 W |
| 3679 | 4822 116 52776 | 2.2 kΩ | 0,4 W |
| 3683 | 4822 116 53087 | 1.2 kΩ | 0,4 W |
| 3705 | 4822 116 53028 | 7.5 kΩ | 0,6 W |
| 3715 | 4822 100 20488 | 470 Ω | potm. |
| 3935 | 4822 111 30498 | 4.3 Ω | 0,33 W |



| | | | |
|------|----------------|--------|--------|
| 2544 | 4822 121 42477 | 47 nF | 50 V |
| 2553 | 4822 121 42477 | 47 nF | 50 V |
| 2554 | 4822 121 50753 | 2.2 nF | 160 V |
| 2572 | 4822 121 42477 | 47 nF | 50 V |
| 2608 | 4822 124 21208 | 4.7 μF | 50 V |
| 2609 | 4822 121 40249 | 8.2 nF | 1600 V |
| 2609 | 4822 121 42383 | 6.2 nF | 2000 V |
| 2611 | 4822 121 40479 | 390 nF | 250 V |
| 2612 | 4822 121 42597 | 360 nF | 250 V |
| 2612 | 4822 121 42376 | 470 nF | 250 V |
| 2617 | 4822 122 32771 | 1.5 nF | 2000 V |
| 2617 | 4822 122 20039 | 270 pF | 2000 V |
| 2638 | 4822 124 21923 | 3.3 μF | 250 V |
| 2651 | 4822 121 50627 | 470 nF | 250 V |
| 2654 | 4822 122 32769 | 2.2 nF | 1000 V |
| 2655 | 4822 122 32769 | 2.2 nF | 1000 V |
| 2656 | 4822 122 32769 | 2.2 nF | 1000 V |
| 2657 | 4822 122 32769 | 2.2 nF | 1000 V |
| 2659 | 4822 124 21686 | 220 μF | 385 V |
| 2664 | 4822 122 32071 | 2.2 nF | 1000 V |
| 2675 | 4822 121 42589 | 82 nF | 63 V |
| 2690 | 4822 124 41282 | 1 μF | 50 V |
| 2691 | 4822 122 20038 | 47 pF | |
| 2694 | 4822 122 20039 | 270 pF | 2000 V |



| | | | |
|------|----------------|---------|------------|
| 1601 | 4822 253 30174 | T125 mA | (for 90°) |
| 1601 | 4822 253 10074 | T315 mA | (for 110°) |
| 1642 | 4822 253 10057 | T800 mA | |
| 1651 | 4822 253 30025 | T2 A | |
| 1704 | 4822 253 30089 | T2,5 A | |
| 1707 | 4822 253 30089 | T2,5 A | |
| 1711 | 4822 253 10074 | T315 mA | |



(board)







| | | |
|------------|----------------|-----|
| M4 | 4822 265 40442 | 10p |
| M5 | 4822 267 40648 | 5p |
| M6 | 4822 264 50149 | 10p |
| M7 | 4822 264 50148 | 8p |
| M8 | 4822 264 50148 | 8p |
| M9 | 4822 267 50591 | 6p |
| M10 | 4822 264 50148 | 8p |
| M11 | 4822 265 30437 | 3p |
| M12 | 4822 265 40422 | 8p |
| M13 | 4822 265 30351 | 5p |
| M14 | 4822 265 30378 | 4p |
| M15 | 4822 265 30389 | 2p |
| M16 | 4822 265 30407 | 3p |
| M17 | 4822 265 40421 | 6p |
| M18 | 4822 265 30389 | 2p |
| M19 | 4822 265 30389 | 2p |





(cable)

| | | |
|------------|----------------|-----|
| M4 | 4822 267 50637 | 10p |
| M12 | 4822 265 40253 | 8p |
| M13 | 4822 265 30275 | 5p |
| M14 | 4822 267 40507 | 4p |
| M15 | 4822 267 40653 | 3p |
| M16 | 4822 265 30273 | 3p |
| M17 | 4822 267 30546 | 6p |
| M18 | 4822 267 30639 | 2p |
| M19 | 4822 267 30639 | 2p |



PICTURE TUBE PANEL 1400

| | | | | | | | | | | | | | | | | | | | | | | | | | | | | | | | | | | | | | | | | | | | | | | | | | | | | | | | | | | | | | | | | | | | | | | | | | | | | | | | | | | | | | |
|--|---|--------|----------------|-------|--------|------|----------------|--------|--------|------|----------------|------|--------|------|----------------|------|--------|------|----------------|------|-------|------|----------------|--------|-------|------|----------------|--------|--------|------|----------------|------|--------|------|----------------|------|--------|------|----------------|------|-------|------|----------------|--------|-------|------|----------------|--------|--------|------|----------------|------|--------|------|----------------|------|--------|------|----------------|--------|-------|------|----------------|--------|-------|------|----------------|--------|-------|------|----------------|--------|-------|------|----------------|--------|--------|------|----------------|--------|-------|------|----------------|--------|-------|
|  | BC548C 4822 130 44196 BC558B 4822 130 44197 BF423 4822 130 41646 BF485 4822 130 42702 BF583 4822 130 60143 BF870 4822 130 60126 | | | | | | | | | | | | | | | | | | | | | | | | | | | | | | | | | | | | | | | | | | | | | | | | | | | | | | | | | | | | | | | | | | | | | | | | | | | | | | | | | | | | |
|  | 1N4148 4822 130 31438 | | | | | | | | | | | | | | | | | | | | | | | | | | | | | | | | | | | | | | | | | | | | | | | | | | | | | | | | | | | | | | | | | | | | | | | | | | | | | | | | | | | | |
|  | <table border="0"> <tbody> <tr><td>3400</td><td>4822 111 30539</td><td>150 Ω</td><td>0,33 W</td></tr> <tr><td>3401</td><td>4822 111 30582</td><td>6.2 kΩ</td><td>0,33 W</td></tr> <tr><td>3402</td><td>4822 111 30568</td><td>2 kΩ</td><td>0,33 W</td></tr> <tr><td>3402</td><td>4822 111 30561</td><td>1 kΩ</td><td>0,33 W</td></tr> <tr><td>3414</td><td>4822 100 20148</td><td>1 kΩ</td><td>potm.</td></tr> <tr><td>3419</td><td>4822 116 52408</td><td>2.2 kΩ</td><td>0,5 W</td></tr> <tr><td>3421</td><td>4822 111 30582</td><td>6.2 kΩ</td><td>0,33 W</td></tr> <tr><td>3422</td><td>4822 111 30568</td><td>2 kΩ</td><td>0,33 W</td></tr> <tr><td>3422</td><td>4822 111 30561</td><td>1 kΩ</td><td>0,33 W</td></tr> <tr><td>3434</td><td>4822 100 20148</td><td>1 kΩ</td><td>potm.</td></tr> <tr><td>3439</td><td>4822 116 52408</td><td>2.2 kΩ</td><td>0,5 W</td></tr> <tr><td>3441</td><td>4822 111 30582</td><td>6.2 kΩ</td><td>0,33 W</td></tr> <tr><td>3442</td><td>4822 111 30568</td><td>2 kΩ</td><td>0,33 W</td></tr> <tr><td>3442</td><td>4822 111 30561</td><td>1 kΩ</td><td>0,33 W</td></tr> <tr><td>3459</td><td>4822 116 52408</td><td>2.2 kΩ</td><td>0,5 W</td></tr> <tr><td>3470</td><td>4822 116 52408</td><td>2.2 kΩ</td><td>0,5 W</td></tr> <tr><td>3471</td><td>4822 116 52413</td><td>2.7 kΩ</td><td>0,5 W</td></tr> <tr><td>3472</td><td>4822 101 10127</td><td>4.7 MΩ</td><td>potm.</td></tr> <tr><td>3473</td><td>5322 116 52489</td><td>1.3 MΩ</td><td>0,25 W</td></tr> <tr><td>3491</td><td>4822 116 53105</td><td>3.3 kΩ</td><td>0,6 W</td></tr> <tr><td>3492</td><td>4822 116 52776</td><td>2.2 kΩ</td><td>0,4 W</td></tr> </tbody> </table> | 3400 | 4822 111 30539 | 150 Ω | 0,33 W | 3401 | 4822 111 30582 | 6.2 kΩ | 0,33 W | 3402 | 4822 111 30568 | 2 kΩ | 0,33 W | 3402 | 4822 111 30561 | 1 kΩ | 0,33 W | 3414 | 4822 100 20148 | 1 kΩ | potm. | 3419 | 4822 116 52408 | 2.2 kΩ | 0,5 W | 3421 | 4822 111 30582 | 6.2 kΩ | 0,33 W | 3422 | 4822 111 30568 | 2 kΩ | 0,33 W | 3422 | 4822 111 30561 | 1 kΩ | 0,33 W | 3434 | 4822 100 20148 | 1 kΩ | potm. | 3439 | 4822 116 52408 | 2.2 kΩ | 0,5 W | 3441 | 4822 111 30582 | 6.2 kΩ | 0,33 W | 3442 | 4822 111 30568 | 2 kΩ | 0,33 W | 3442 | 4822 111 30561 | 1 kΩ | 0,33 W | 3459 | 4822 116 52408 | 2.2 kΩ | 0,5 W | 3470 | 4822 116 52408 | 2.2 kΩ | 0,5 W | 3471 | 4822 116 52413 | 2.7 kΩ | 0,5 W | 3472 | 4822 101 10127 | 4.7 MΩ | potm. | 3473 | 5322 116 52489 | 1.3 MΩ | 0,25 W | 3491 | 4822 116 53105 | 3.3 kΩ | 0,6 W | 3492 | 4822 116 52776 | 2.2 kΩ | 0,4 W |
| 3400 | 4822 111 30539 | 150 Ω | 0,33 W | | | | | | | | | | | | | | | | | | | | | | | | | | | | | | | | | | | | | | | | | | | | | | | | | | | | | | | | | | | | | | | | | | | | | | | | | | | | | | | | | | |
| 3401 | 4822 111 30582 | 6.2 kΩ | 0,33 W | | | | | | | | | | | | | | | | | | | | | | | | | | | | | | | | | | | | | | | | | | | | | | | | | | | | | | | | | | | | | | | | | | | | | | | | | | | | | | | | | | |
| 3402 | 4822 111 30568 | 2 kΩ | 0,33 W | | | | | | | | | | | | | | | | | | | | | | | | | | | | | | | | | | | | | | | | | | | | | | | | | | | | | | | | | | | | | | | | | | | | | | | | | | | | | | | | | | |
| 3402 | 4822 111 30561 | 1 kΩ | 0,33 W | | | | | | | | | | | | | | | | | | | | | | | | | | | | | | | | | | | | | | | | | | | | | | | | | | | | | | | | | | | | | | | | | | | | | | | | | | | | | | | | | | |
| 3414 | 4822 100 20148 | 1 kΩ | potm. | | | | | | | | | | | | | | | | | | | | | | | | | | | | | | | | | | | | | | | | | | | | | | | | | | | | | | | | | | | | | | | | | | | | | | | | | | | | | | | | | | |
| 3419 | 4822 116 52408 | 2.2 kΩ | 0,5 W | | | | | | | | | | | | | | | | | | | | | | | | | | | | | | | | | | | | | | | | | | | | | | | | | | | | | | | | | | | | | | | | | | | | | | | | | | | | | | | | | | |
| 3421 | 4822 111 30582 | 6.2 kΩ | 0,33 W | | | | | | | | | | | | | | | | | | | | | | | | | | | | | | | | | | | | | | | | | | | | | | | | | | | | | | | | | | | | | | | | | | | | | | | | | | | | | | | | | | |
| 3422 | 4822 111 30568 | 2 kΩ | 0,33 W | | | | | | | | | | | | | | | | | | | | | | | | | | | | | | | | | | | | | | | | | | | | | | | | | | | | | | | | | | | | | | | | | | | | | | | | | | | | | | | | | | |
| 3422 | 4822 111 30561 | 1 kΩ | 0,33 W | | | | | | | | | | | | | | | | | | | | | | | | | | | | | | | | | | | | | | | | | | | | | | | | | | | | | | | | | | | | | | | | | | | | | | | | | | | | | | | | | | |
| 3434 | 4822 100 20148 | 1 kΩ | potm. | | | | | | | | | | | | | | | | | | | | | | | | | | | | | | | | | | | | | | | | | | | | | | | | | | | | | | | | | | | | | | | | | | | | | | | | | | | | | | | | | | |
| 3439 | 4822 116 52408 | 2.2 kΩ | 0,5 W | | | | | | | | | | | | | | | | | | | | | | | | | | | | | | | | | | | | | | | | | | | | | | | | | | | | | | | | | | | | | | | | | | | | | | | | | | | | | | | | | | |
| 3441 | 4822 111 30582 | 6.2 kΩ | 0,33 W | | | | | | | | | | | | | | | | | | | | | | | | | | | | | | | | | | | | | | | | | | | | | | | | | | | | | | | | | | | | | | | | | | | | | | | | | | | | | | | | | | |
| 3442 | 4822 111 30568 | 2 kΩ | 0,33 W | | | | | | | | | | | | | | | | | | | | | | | | | | | | | | | | | | | | | | | | | | | | | | | | | | | | | | | | | | | | | | | | | | | | | | | | | | | | | | | | | | |
| 3442 | 4822 111 30561 | 1 kΩ | 0,33 W | | | | | | | | | | | | | | | | | | | | | | | | | | | | | | | | | | | | | | | | | | | | | | | | | | | | | | | | | | | | | | | | | | | | | | | | | | | | | | | | | | |
| 3459 | 4822 116 52408 | 2.2 kΩ | 0,5 W | | | | | | | | | | | | | | | | | | | | | | | | | | | | | | | | | | | | | | | | | | | | | | | | | | | | | | | | | | | | | | | | | | | | | | | | | | | | | | | | | | |
| 3470 | 4822 116 52408 | 2.2 kΩ | 0,5 W | | | | | | | | | | | | | | | | | | | | | | | | | | | | | | | | | | | | | | | | | | | | | | | | | | | | | | | | | | | | | | | | | | | | | | | | | | | | | | | | | | |
| 3471 | 4822 116 52413 | 2.7 kΩ | 0,5 W | | | | | | | | | | | | | | | | | | | | | | | | | | | | | | | | | | | | | | | | | | | | | | | | | | | | | | | | | | | | | | | | | | | | | | | | | | | | | | | | | | |
| 3472 | 4822 101 10127 | 4.7 MΩ | potm. | | | | | | | | | | | | | | | | | | | | | | | | | | | | | | | | | | | | | | | | | | | | | | | | | | | | | | | | | | | | | | | | | | | | | | | | | | | | | | | | | | |
| 3473 | 5322 116 52489 | 1.3 MΩ | 0,25 W | | | | | | | | | | | | | | | | | | | | | | | | | | | | | | | | | | | | | | | | | | | | | | | | | | | | | | | | | | | | | | | | | | | | | | | | | | | | | | | | | | |
| 3491 | 4822 116 53105 | 3.3 kΩ | 0,6 W | | | | | | | | | | | | | | | | | | | | | | | | | | | | | | | | | | | | | | | | | | | | | | | | | | | | | | | | | | | | | | | | | | | | | | | | | | | | | | | | | | |
| 3492 | 4822 116 52776 | 2.2 kΩ | 0,4 W | | | | | | | | | | | | | | | | | | | | | | | | | | | | | | | | | | | | | | | | | | | | | | | | | | | | | | | | | | | | | | | | | | | | | | | | | | | | | | | | | | |
|  | 2466 4822 122 31695 1 nF 2000 V | | | | | | | | | | | | | | | | | | | | | | | | | | | | | | | | | | | | | | | | | | | | | | | | | | | | | | | | | | | | | | | | | | | | | | | | | | | | | | | | | | | | |
|  | (board) | | | | | | | | | | | | | | | | | | | | | | | | | | | | | | | | | | | | | | | | | | | | | | | | | | | | | | | | | | | | | | | | | | | | | | | | | | | | | | | | | | | | |
| P12 | 4822 265 40422 8p | | | | | | | | | | | | | | | | | | | | | | | | | | | | | | | | | | | | | | | | | | | | | | | | | | | | | | | | | | | | | | | | | | | | | | | | | | | | | | | | | | | | |
| P13 | 4822 265 30351 5p | | | | | | | | | | | | | | | | | | | | | | | | | | | | | | | | | | | | | | | | | | | | | | | | | | | | | | | | | | | | | | | | | | | | | | | | | | | | | | | | | | | | |
| P1 | 4822 265 30407 3p | | | | | | | | | | | | | | | | | | | | | | | | | | | | | | | | | | | | | | | | | | | | | | | | | | | | | | | | | | | | | | | | | | | | | | | | | | | | | | | | | | | | |
|  | (cable) | | | | | | | | | | | | | | | | | | | | | | | | | | | | | | | | | | | | | | | | | | | | | | | | | | | | | | | | | | | | | | | | | | | | | | | | | | | | | | | | | | | | |
| P12 | 4822 265 40253 8p | | | | | | | | | | | | | | | | | | | | | | | | | | | | | | | | | | | | | | | | | | | | | | | | | | | | | | | | | | | | | | | | | | | | | | | | | | | | | | | | | | | | |
| P13 | 4822 265 30275 5p | | | | | | | | | | | | | | | | | | | | | | | | | | | | | | | | | | | | | | | | | | | | | | | | | | | | | | | | | | | | | | | | | | | | | | | | | | | | | | | | | | | | |
| P1 | 4822 265 30273 3p | | | | | | | | | | | | | | | | | | | | | | | | | | | | | | | | | | | | | | | | | | | | | | | | | | | | | | | | | | | | | | | | | | | | | | | | | | | | | | | | | | | | |
| Various | | | | | | | | | | | | | | | | | | | | | | | | | | | | | | | | | | | | | | | | | | | | | | | | | | | | | | | | | | | | | | | | | | | | | | | | | | | | | | | | | | | | | |
| 1474 | 4822 101 20814 Focus pot. meter 4822 255 70216 Socket picture tube | | | | | | | | | | | | | | | | | | | | | | | | | | | | | | | | | | | | | | | | | | | | | | | | | | | | | | | | | | | | | | | | | | | | | | | | | | | | | | | | | | | | |



AUXILIARY PANEL NEAR SYNC. IC

| | | | | | | | | | | | | | |
|---|---|--------|----------------|--------|--------|------|----------------|-------|--------|------|----------------|--------|--------|
|  | BC557 4822 130 44256 BC558 4822 130 40941 | | | | | | | | | | | | |
|  | BZX55-C33 4822 130 33684 BZX79-C12 4822 130 34197 1N4148 4822 130 31438 | | | | | | | | | | | | |
|  | <table border="0"> <tbody> <tr><td>3548</td><td>4822 110 72203</td><td>3.9 MΩ</td><td>0,25 W</td></tr> <tr><td>3549</td><td>4822 110 72214</td><td>10 MΩ</td><td>0,25 W</td></tr> <tr><td>3550</td><td>4822 110 72189</td><td>1.2 MΩ</td><td>0,25 W</td></tr> </tbody> </table> | 3548 | 4822 110 72203 | 3.9 MΩ | 0,25 W | 3549 | 4822 110 72214 | 10 MΩ | 0,25 W | 3550 | 4822 110 72189 | 1.2 MΩ | 0,25 W |
| 3548 | 4822 110 72203 | 3.9 MΩ | 0,25 W | | | | | | | | | | |
| 3549 | 4822 110 72214 | 10 MΩ | 0,25 W | | | | | | | | | | |
| 3550 | 4822 110 72189 | 1.2 MΩ | 0,25 W | | | | | | | | | | |

HEADPHONE PANEL 1250

| | |
|---|--|
|  | 2244 4822 124 21941 2.2 μF 63 V 2245 4822 124 21941 2.2 μF 63 V |
|  | (board) |
| H1+H4 | 4822 265 30407 3p |
| H5 | 4822 265 30378 4p |
| H14 | 4822 265 30378 4p |
|  | (cable) |
| H1+H4 | 4822 265 30273 3p |
| H5 | 4822 265 40507 4p |
| H14 | 4822 265 40507 4p |
| Various | |
| | 4822 267 30324 Socket,jack 4822 404 30643 Bracket |

MAINS FILTER 1950 (ONLY FOR 24 INCH)

| | |
|---|----------------------------------|
|  | 2101 4822 121 50627 470 nF 250 V |
|  | 5101 4822 158 30208 |

1100 STEREO SOUND MODULE

MODULO SONIDO STEREO

MÓDULOS SONIDO ESTEREOFONIE

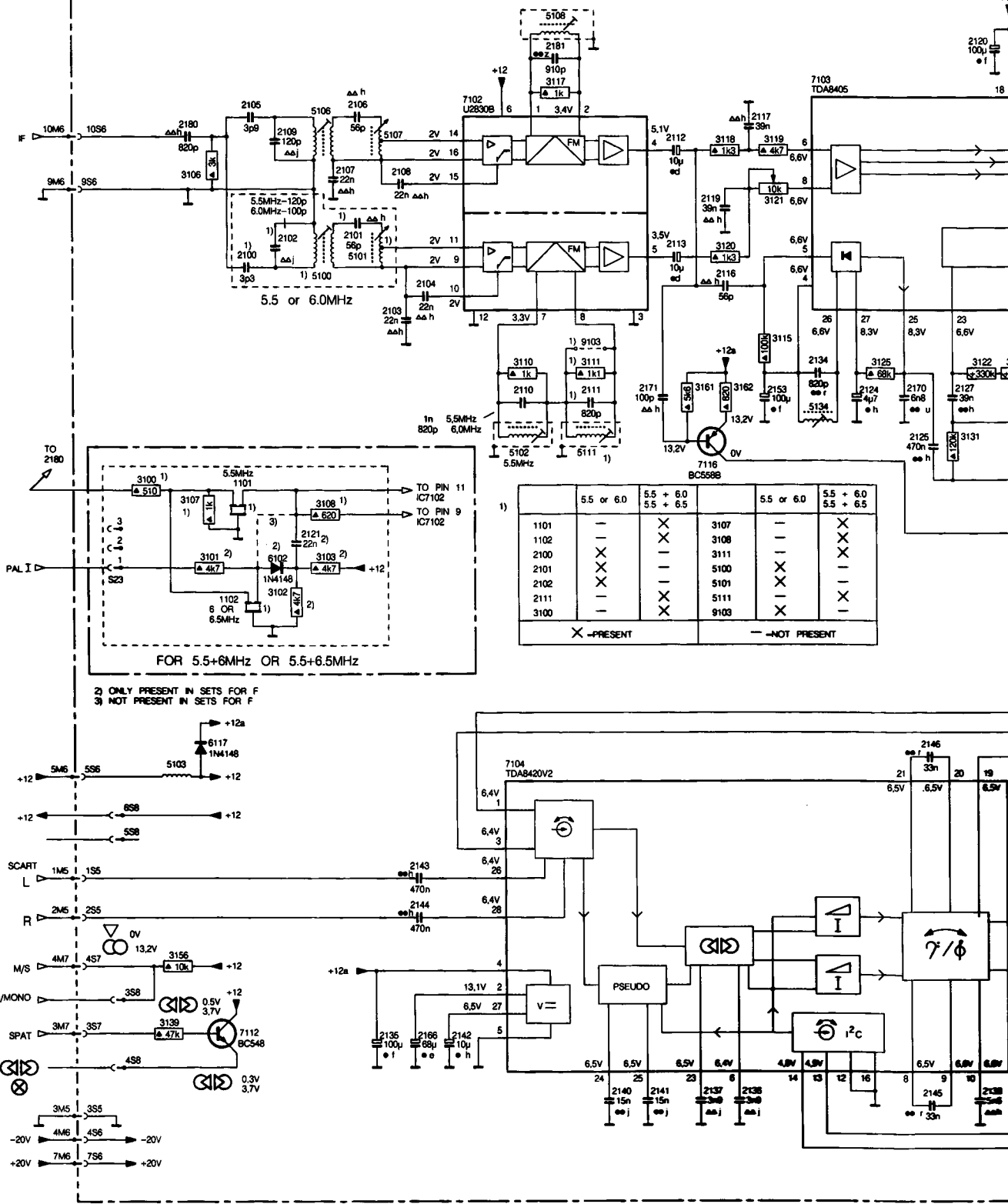

5.5 or 6.0MHz

FOR 5.5+6MHz OR 5.5+6.5MHz

2) ONLY PRESENT IN SETS FOR F
3) NOT PRESENT IN SETS FOR F

| | 5.5 or 6.0 | 5.5 + 6.0 5.5 + 6.5 | 5.5 or 6.0 | 5.5 + 6.0 5.5 + 6.5 |
|------|------------|------------------------|------------|------------------------|
| 1101 | — | X | 3107 | — |
| 1102 | — | X | 3108 | — |
| 2100 | X | — | 3111 | X |
| 2101 | X | — | 5100 | X |
| 2102 | X | — | 5101 | X |
| 2111 | — | X | 5111 | X |
| 3100 | — | X | 9103 | — |

X - PRESENT — NOT PRESENT

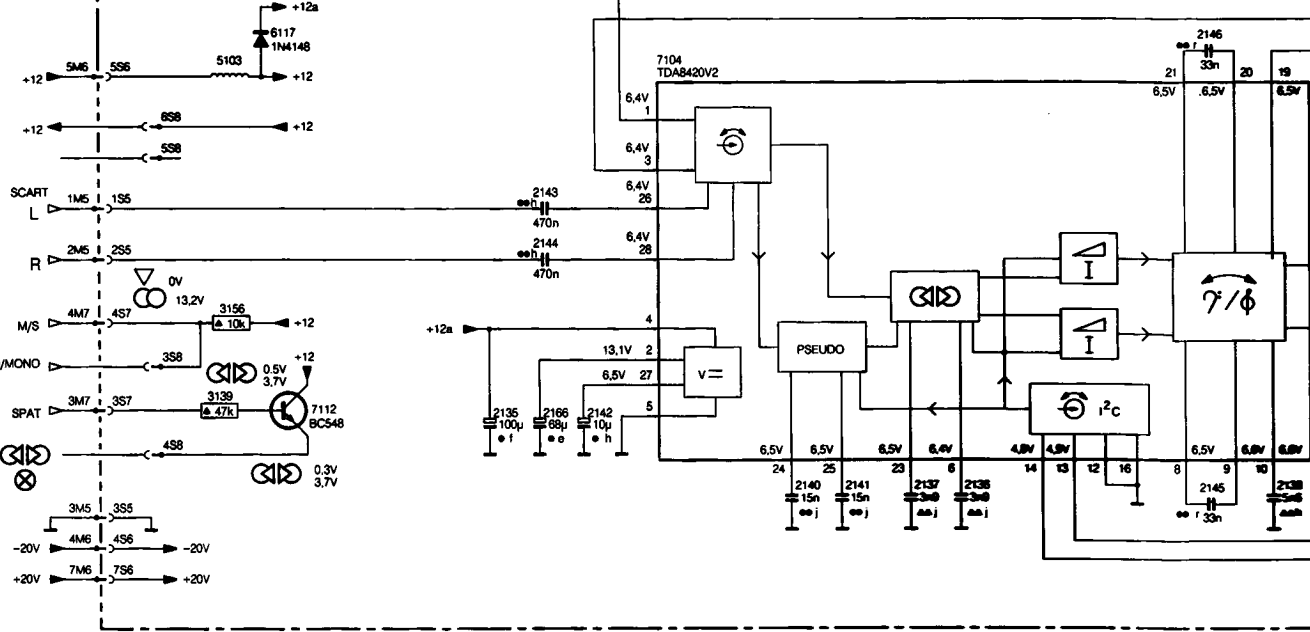

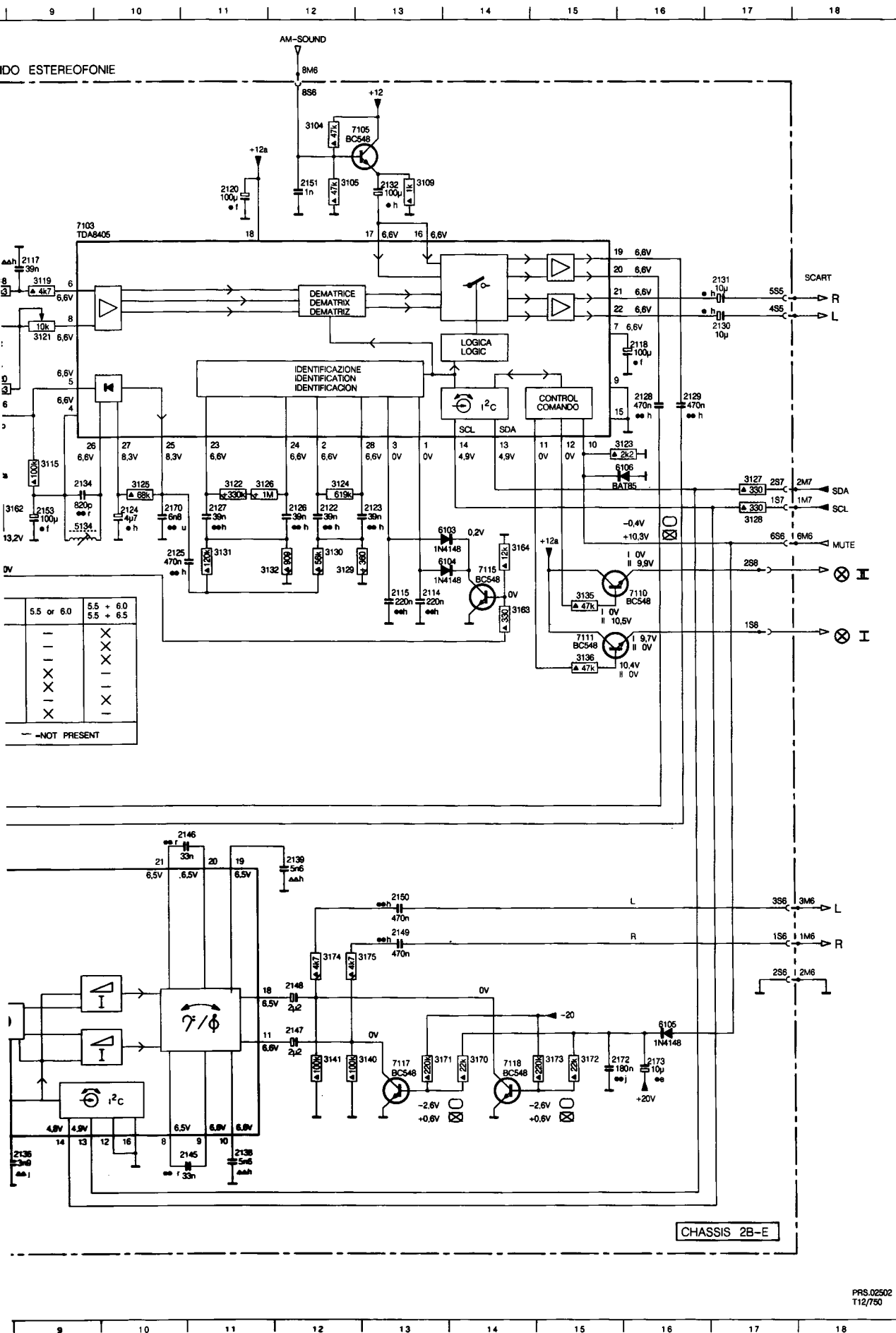

| | |
|--------|-------|
| 1100 | A 2 |
| 1101 | G 3 |
| 1102 | H 3 |
| 2100 | D 3 |
| 2101 | D 4 |
| 2102 | D 4 |
| 2103 | D 4 |
| A 2103 | E 5 |
| 2104 | E 5 |
| 2105 | C C 3 |
| 2106 | C C 5 |
| 2107 | C 4 |
| 2108 | D D 5 |
| 2109 | C C 4 |
| 2110 | F 6 |
| 2111 | F 7 |
| 2112 | D C 8 |
| 2113 | D C 8 |
| 2114 | G 13 |
| 2115 | G 13 |
| 2116 | E 8 |
| 2117 | C C 9 |
| 2118 | D 16 |
| 2119 | D 8 |
| 2120 | B 1 |
| 2121 | G 4 |
| 2122 | F 12 |
| 2123 | F 13 |
| 2124 | F 10 |
| 2125 | F 10 |
| 2126 | F 12 |
| 2127 | F 11 |
| 2128 | D 16 |
| 2129 | D 16 |
| 2130 | D 17 |
| 2131 | G 17 |
| D 2132 | B 13 |
| 2134 | E 9 |
| 2135 | L 5 |
| 2136 | M 9 |
| 2137 | M 8 |
| 2138 | M 1 |
| 2139 | J 12 |
| 2140 | M 7 |
| 2141 | M 8 |
| E 2142 | L 6 |
| 2143 | K 5 |
| 2144 | K 5 |
| 2145 | M 1 |
| 2146 | I 11 |
| 2147 | K 12 |
| 2148 | K 12 |
| 2149 | J 13 |
| 2150 | J 13 |
| 2151 | B 12 |
| F 2152 | F 9 |
| 2166 | L 5 |
| 2170 | F 10 |
| 2171 | F 8 |
| 2172 | L 16 |
| 2173 | L 16 |
| 2180 | C 3 |
| 2181 | B 7 |
| 3100 | G 2 |
| 3101 | G 3 |
| G 3102 | H 4 |
| 3103 | G 4 |
| 3104 | A 12 |
| 3105 | B 12 |
| 3106 | D 3 |
| 3107 | G 3 |
| 3108 | G 4 |
| 3109 | B 13 |
| 3110 | E 6 |
| 3111 | E 7 |
| H 3115 | E 9 |
| 3117 | C C 7 |
| 3118 | C 9 |
| 3119 | C 9 |
| 3120 | D 8 |
| 3121 | D 9 |
| 3122 | E 11 |
| 3123 | E 16 |
| 3124 | E 12 |
| I 3125 | E 10 |
| 3126 | E 11 |
| 3127 | E 17 |
| 3128 | F 17 |
| 3129 | F 12 |
| 3130 | F 12 |
| 3131 | F 11 |
| 3132 | F 12 |
| J 3135 | G 15 |
| 3136 | G 15 |
| 3139 | L 2 |
| 3140 | L 13 |
| 3141 | L 13 |
| 3156 | K 3 |
| 3161 | F 8 |
| 3162 | F 9 |
| 3163 | G 14 |
| 3164 | F 14 |
| 3170 | L 14 |
| K 3171 | L 13 |
| 3172 | L 15 |
| 3173 | L 15 |
| 3174 | K 12 |
| 3175 | K 13 |
| 3176 | E 4 |
| E 5101 | D 5 |
| 5102 | F 6 |
| 5103 | J 3 |
| 5106 | C 4 |
| 5107 | C 5 |
| L 5108 | B 7 |
| 5111 | F 7 |
| 5134 | F 9 |
| 6102 | G 4 |
| 6103 | F 14 |
| 6104 | F 14 |
| 6105 | K 16 |
| 6106 | E 16 |
| 6117 | I 3 |
| M 7102 | C 6 |
| 7103 | C 9 |
| J 7104 | J 6 |
| 7105 | B 13 |
| 7110 | G 16 |
| 7111 | G 15 |
| 7112 | L 3 |
| 7116 | F 8 |
| 7117 | L 13 |
| 7118 | L 14 |
| N 9103 | E 7 |

| | |
|------------|-----------|
| 5.5 or 6.0 | 5.5 + 6.0 |
| - | X |
| - | X |
| X | - |
| X | - |
| X | X |
| - | - |
| - | - |
| - | - |
| - | - |

- - NOT PRESENT

PRS.02502
T12/750

1300 CHROMINANCE DECODER DECODIFICATORE CROMINANZA DECODIFICADOR

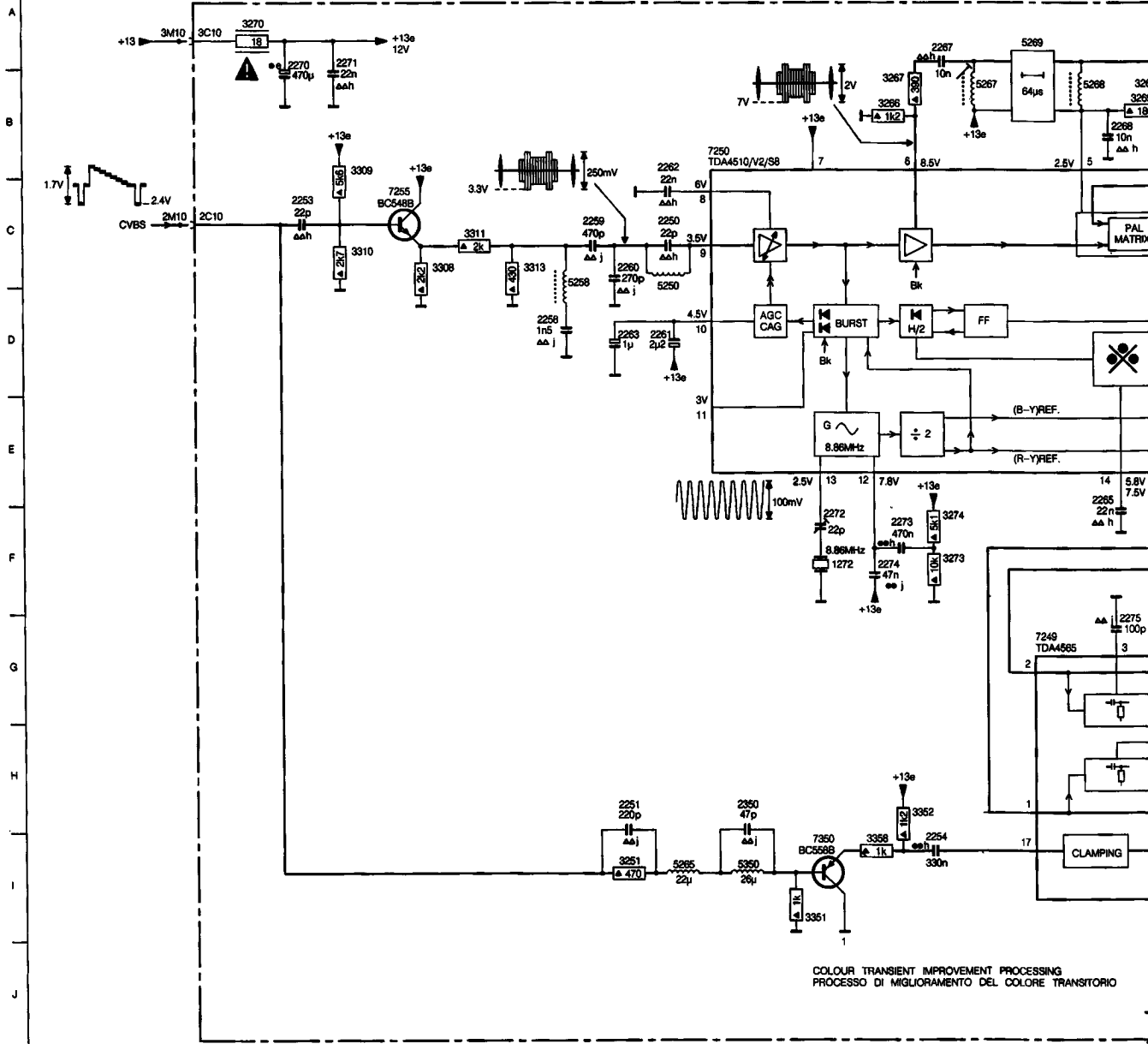

COLOUR TRANSIENT IMPROVEMENT PROCESSING
PROCESSO DI MIGLIORAMENTO DEL COLORE TRANSITORIO



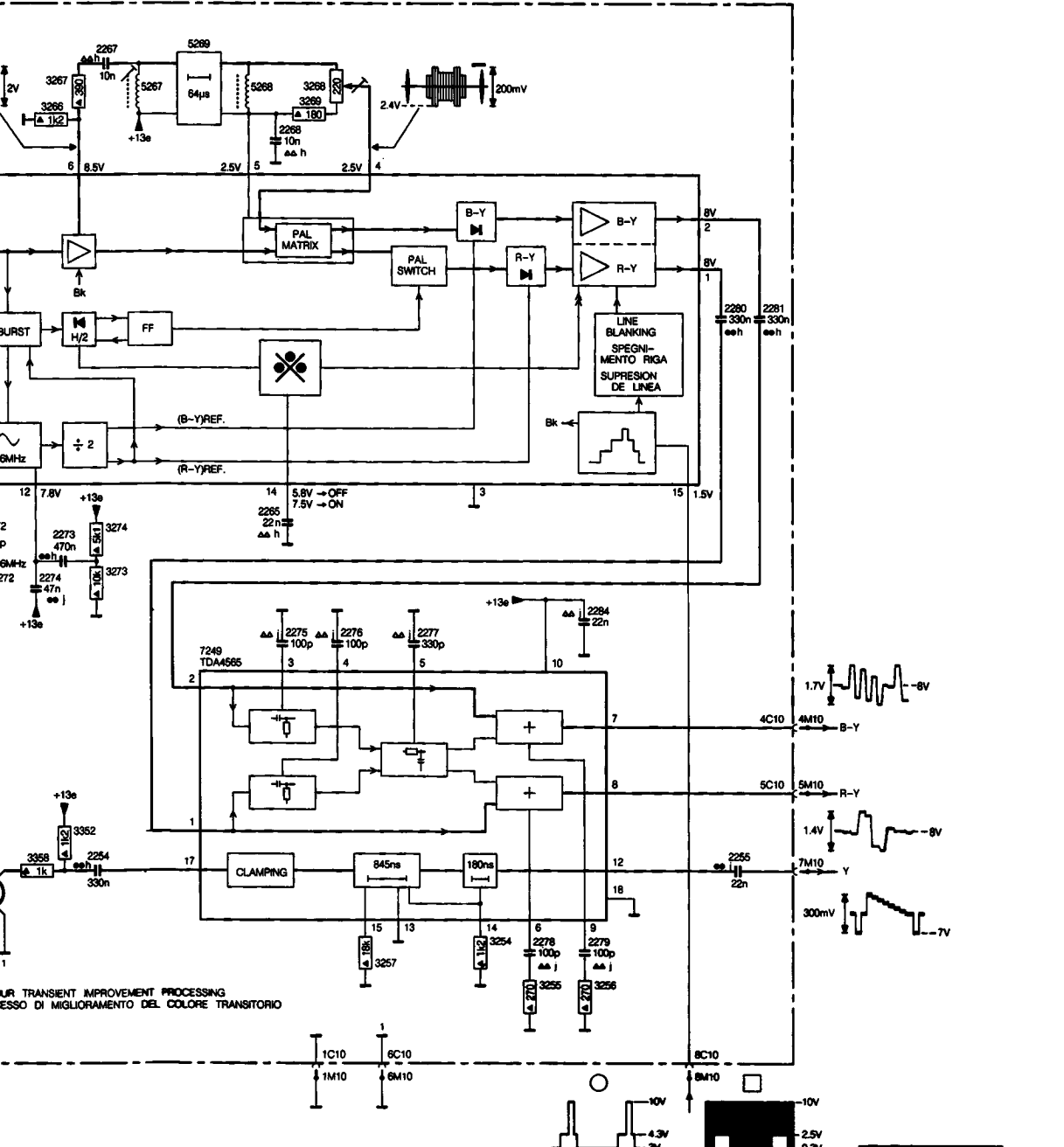



MINANZA DECODIFICADOR CROMINANCIA PAL-CTI





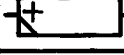
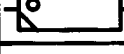

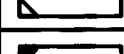
| | |
|------|------|
| 1272 | F 8 |
| 2250 | C 6 |
| 2251 | H 6 |
| 2253 | C 3 |
| 2254 | I 9 |
| 2255 | I 15 |
| 2258 | C 5 |
| 2259 | C 6 |
| 2260 | C 6 |
| 2261 | D 6 |
| 2262 | B 6 |
| 2263 | D 6 |
| 2265 | E 10 |
| 2267 | A 9 |
| 2268 | B 11 |
| 2270 | A 3 |
| 2271 | A 3 |
| 2272 | F 8 |
| 2273 | F 8 |
| 2274 | F 9 |
| 2275 | G 11 |
| 2276 | G 11 |
| 2277 | G 12 |
| 2278 | I 13 |
| 2279 | I 13 |
| 2280 | D 15 |
| 2281 | D 15 |
| 2284 | F 13 |
| 2350 | H 7 |
| 3251 | I 6 |
| 3254 | I 12 |
| 3255 | J 13 |
| 3256 | I 13 |
| 3257 | J 11 |
| 3266 | B 8 |
| 3267 | B 8 |
| 3268 | B 11 |
| 3269 | B 11 |
| 3270 | A 2 |
| 3273 | F 9 |
| 3274 | F 9 |
| 3308 | C 4 |
| 3309 | B 4 |
| 3310 | C 4 |
| 3311 | C 5 |
| 3313 | C 5 |
| 3351 | I 8 |
| 3352 | H 8 |
| 3357 | I 8 |
| 5250 | C 6 |
| 5258 | D 6 |
| 5265 | I 6 |
| 5267 | B 9 |
| 5268 | B 10 |
| 5269 | A 10 |
| 5350 | I 7 |
| 7249 | G 10 |
| 7250 | B 7 |
| 7250 | I 9 |
| 7255 | C 4 |

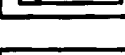
CHASSIS 2B-E PRS 02954 T02-750

SYMBOLS USED IN CIRCUIT DIAGRAMS

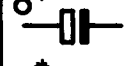
| SYMBOL | TYPE | $t \begin{matrix} P \\ 70^\circ \\ \text{amb} \end{matrix}$ | TOLERANCE | SERIES |
|---|---------|---|-----------------|---------|
|  | SFR16T | 0.5 | 1E - 3M 5% | E24 |
|  | SFR25H | 0.5 | 1E - 10M 5% | E24 |
|  | MRS25 | 0.6 | 1E - 1M 1% | E24 |
|  | MR30 | 0.5 | 1E - 1M 1% (2%) | E24 |
|  | VR37 | 0.5 | 220K - 33M 5% | E24 |
|  | PR37 | 1.6 | 1E - 1M 5% | E24 |
|  | VR68 | 1 | 100K - 68M 5% | E24 |
|  | MRS 16T | 0.4 | 10R - 100K | E24/E96 |

| SYMBOL | TYPE | VOLTAGE DC | TOLERANCE |
|---|-----------------------|------------|-----------------------|
|  | POLYESTER FLATFOIL | SEE NOTE | 10% |
|  | PLATE CERAMIC | SEE NOTE | DEPENDING ON CAPACITY |
|  | ELCO MINIATURE SINGLE | SEE NOTE | -10+50% |
|  | ELCO SINGLE ENDED | SEE NOTE | ±20% |

NOTE:

| | | | | |
|----------|----------|----------|-----------|---------|
| * | f = 25V | q = 200V | x = 1000V | E = 20V |
| | g = 40V | r = 250V | z = 1600V | F = 35V |
| a = 2.5V | h = 63V | s = 300V | A = 1.6V | G = 50V |
| b = 4V | j = 100V | t = 350V | B = 6V | H = 75V |
| c = 6.3V | l = 125V | u = 400V | C = 12V | I = 80V |
| d = 10V | m = 150V | v = 500V | D = 15V | |
| e = 16V | n = 160V | w = 630V | | |

39 301 A13/617

Notes to NICAM faultfinding tree

Note 1

This signal depends on the input signal.
 In case a generator with a NICAM sound signal is used the AF sound signal generated by the generator appears here.
 In case an aerial signal with NICAM sound is used the broadcast AF sound signal appears here.

Note 2

Measurement of the I²S signals must take place as follows.
 Connect one channel of the oscilloscope to the word selection (WS) line. Use this signal also to trigger the oscilloscope.
 Measure with the other channel of the oscilloscope the clock (CL) signal (see fig.1).
 Next connect one channel of the oscilloscope to the clock (CL) line. Use this signal to trigger the oscilloscope.
 Measure with the other channel of the oscilloscope the data (DA) signal (see fig.2).

Note 3

The frequency of the clock signal (pin 22) is 728 kHz.
 The data signal (pin 23) is locked to the clock signal and has a maximum frequency equal to the clock frequency (see fig.3).

Note 4

With this measurement the oscilloscope is operated in X-Y operation. Which signal is used as X or Y drive is immaterial; however, the input sensitivities have to be equal (1 V/div). The picture below (see fig.4) must be visible on the oscilloscope now and the cross pattern must be still and straight.

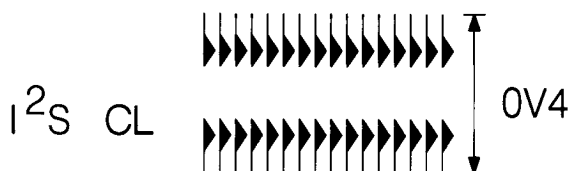
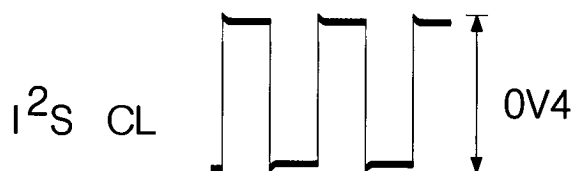
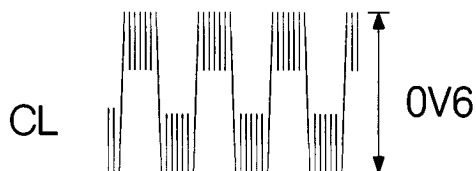

Fig. 1

Fig. 2



QPSK

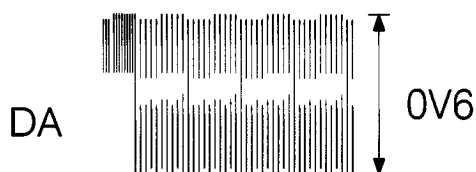

Fig. 3

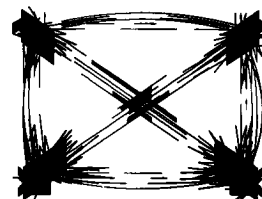







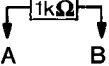

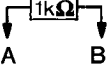

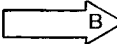









Fig. 4

SYMBOLS FOR FAULT-FINDING TREE

| | | | |
|---|--|--|--|
|  (NICAM) | Connect generator (with NICAM sound) |  (NICAM) | Supply aerial signal (with NICAM sound) |
|  | Correct |  | Incorrect |
|  | Measure the signal/ oscillogram |  | Check circuit between ... and ... |
|  ...  | Check the circuit |  (NICAM) | No or bad NICAM sound |
|  | Insert 1000Ω resistor between A and B |  | Measure frequency |
|  | Measure voltage |  | See faultfinding tree B |

SURVEY OF CONNECTORS

| Board to board Au | | |
|-------------------|---|--|
| | male  | female  |
| 3P | 4822 265 30437 | 4822 265 30431 |
| 4P | 4822 417 50217 | 4822 265 30276 |
| 5P | 4822 267 40648 | 4822 265 40503 |
| 6P | 4822 267 50591 | 4822 265 40469 |
| 8P | 4822 264 50148 | 4822 265 40471 |
| 10P | 4822 264 50149 | 4822 265 40472 |
| Wire to board | | |
| | male  | female  |
| 3P | 4822 264 40207 | 4822 267 40582 |
| 4P | 4822 265 30378 | 4822 267 40597 |
| 5P | 4822 265 30351 | 4822 267 40583 |
| 6P | 4822 265 40421 | 4822 267 40584 |
| 8P | 4822 265 40422 | 4822 267 50544 |
| 10P | 4822 265 40442 | 4822 267 50571 |
| Wire to board | | |
| | male  (edge) | female  |
| 3P | 4822 267 40575 | 4822 267 40582 |
| 4P | 4822 267 40576 | 4822 267 40597 |
| 5P | 4822 265 30497 | 4822 267 40583 |
| 6P | 4822 267 50592 | 4822 267 40584 |
| 8P | 4822 267 50526 | 4822 267 50544 |
| 10P | 4822 267 50593 | 4822 267 50571 |
| Mains | | |
| | male  | female  |
| 2P | 4822 265 30389 | 4822 267 30639 |
| 2P | 4822 265 40596 (STOCKO) | 4822 290 60626 (STOCKO) |

REPAIR METHOD TELETEXT DECODER

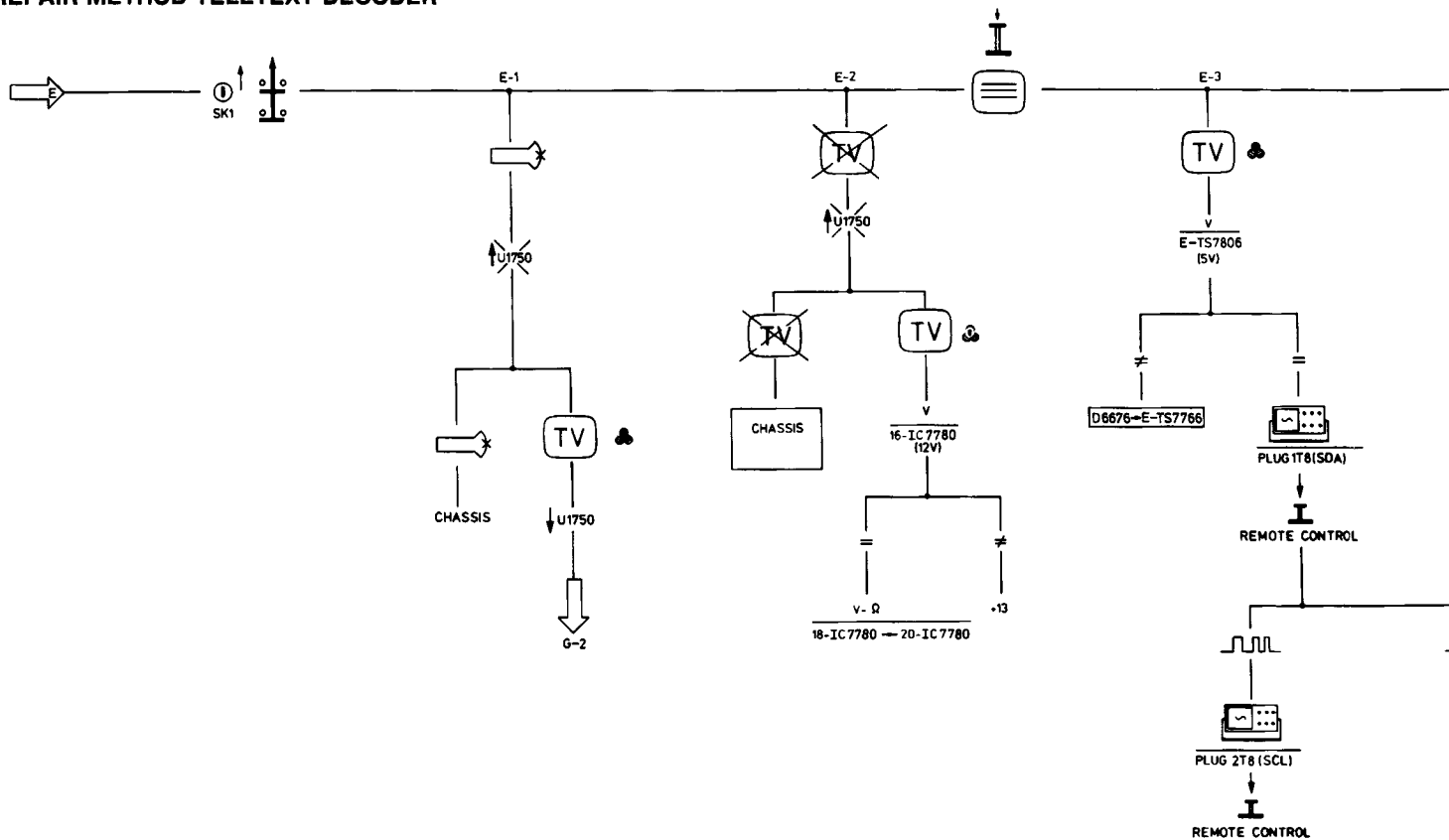

TXT DECODER 1750

| | | | | | |
|---------------|----------------|------|----------------|--------|--------|
| | | | | | |
| MAB8461P-W008 | 4822 209 11235 | 3787 | 4822 111 30494 | 2,7 Ω | 0,33 W |
| MSM2128 | 4822 209 10379 | | | | |
| SAA5230 | 4822 209 82786 | | | | |
| SAA5241A | 4822 209 82819 | | | | |
| SAA5241B | 4822 209 82785 | | | | |
| | | | | | |
| BC548 | 4822 130 40938 | 2788 | 4822 125 50045 | 20 pF | trimm. |
| BC548B | 4822 130 40937 | 2789 | 4822 124 21936 | 2.2 μF | 50 V |
| BC558 | 4822 130 40941 | | | | |
| BC558B | 4822 130 44197 | | | | |
| BD943 | 5322 130 44921 | | | | |
| PH2369 | 4822 130 41594 | | | | |
| | | | | | |
| BYD33G | 4822 130 42489 | | | | |
| BZX55-B5V1 | 4822 130 33524 | | | | |
| BZX55-B8V2 | 4822 130 33526 | | | | |
| | | | | | |
| 5750 | 4822 157 51462 | | | | |
| 5766 | 4822 157 51157 | | | | |
| 5795 | 4822 157 52392 | | | | |
| 5800 | 4822 157 50965 | | | | |
| | | | | | |
| | | T8 | 4822 265 40471 | 8p | |
| | | T9 | 4822 265 40469 | 6p | |

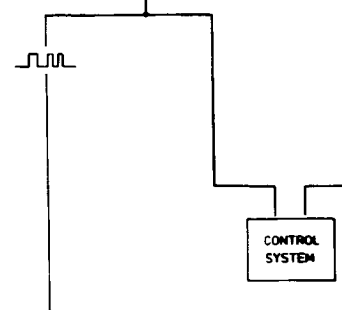

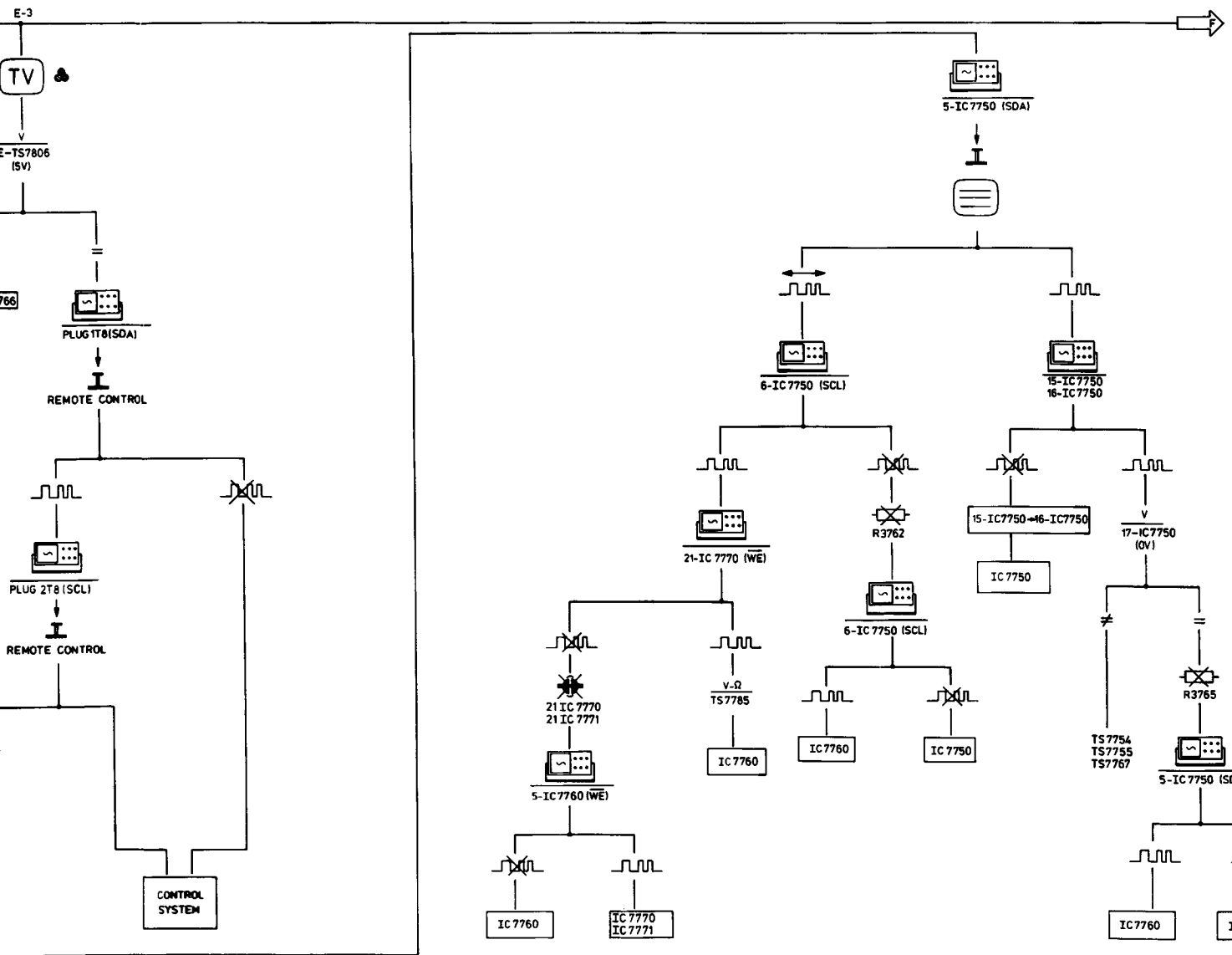

38 865 E12

REPAIR METHOD TELETEXT DECODER

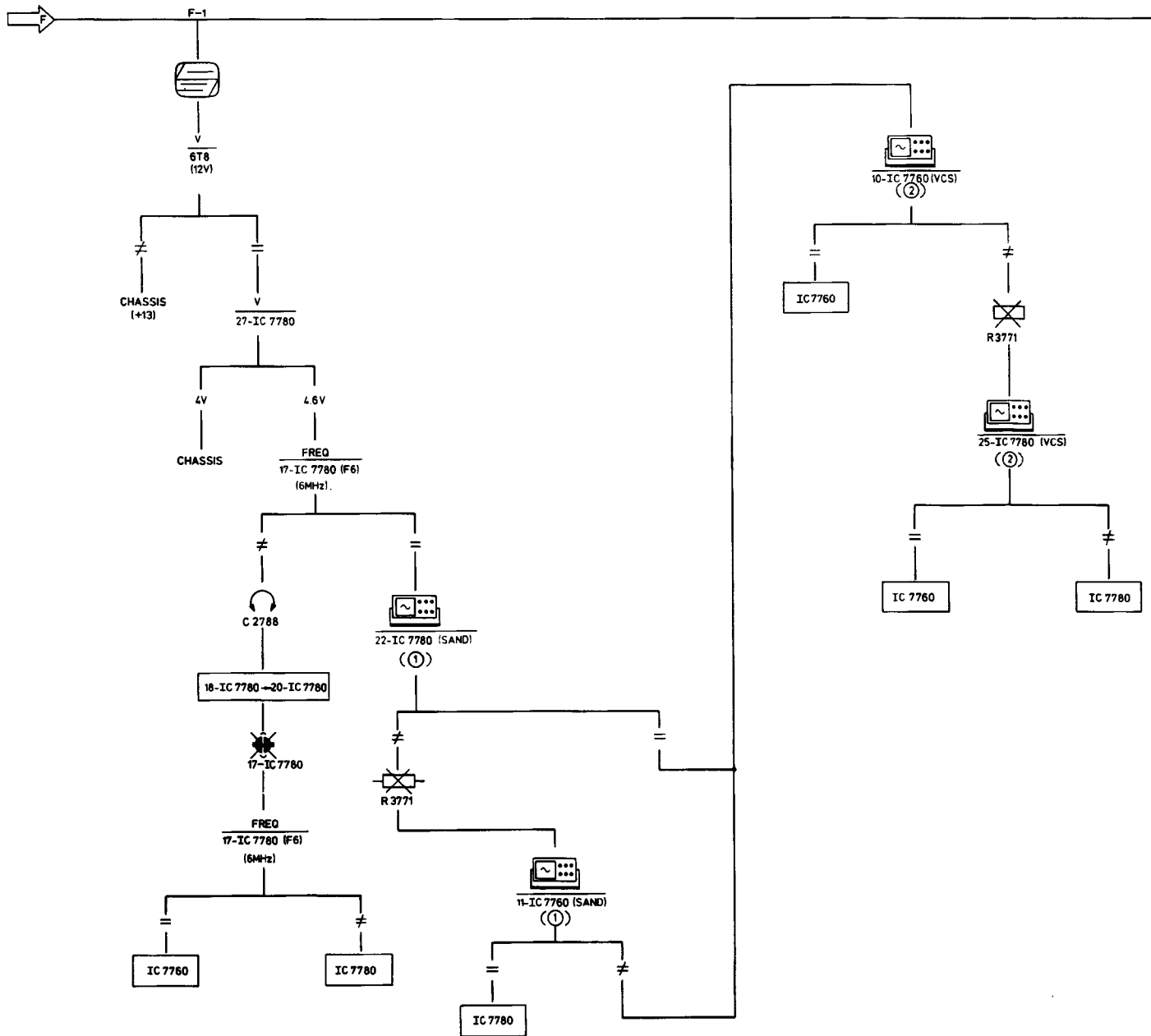

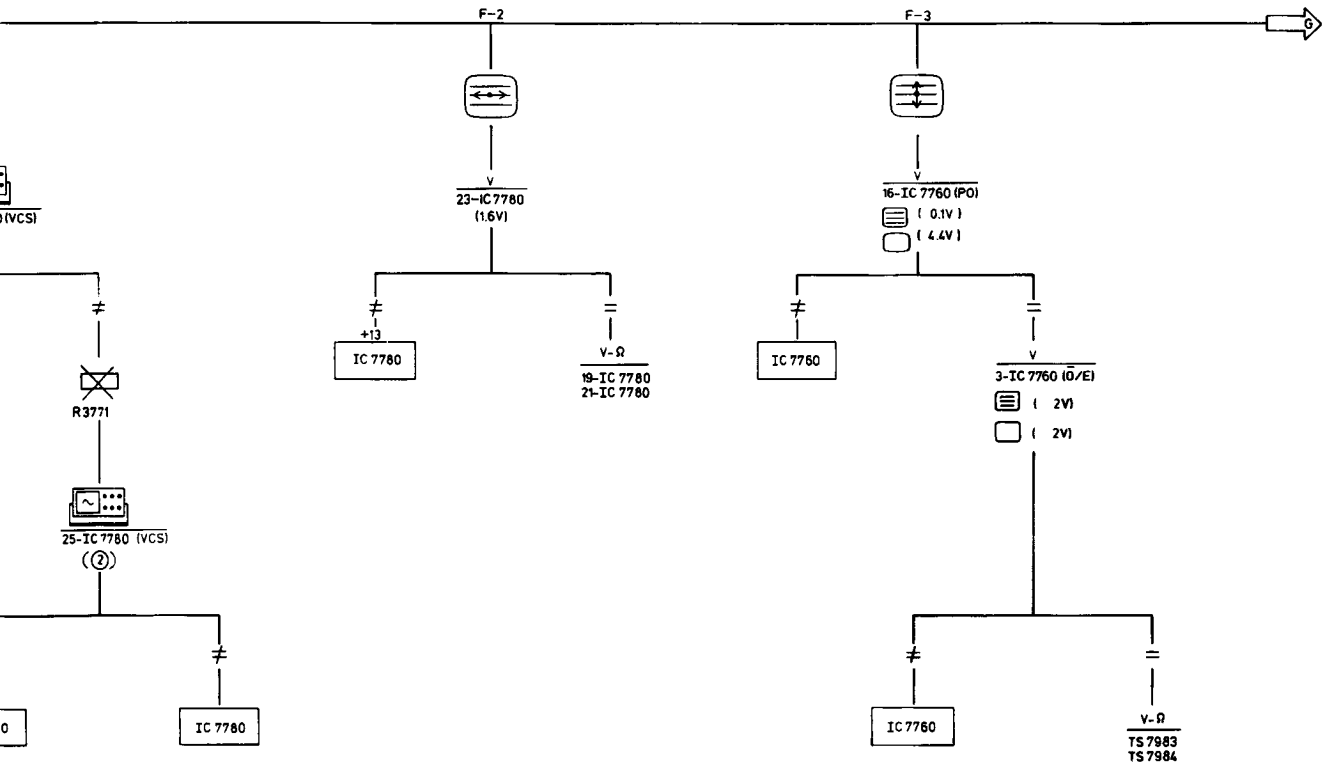

REPAIR METHOD TELETEXT DECODER

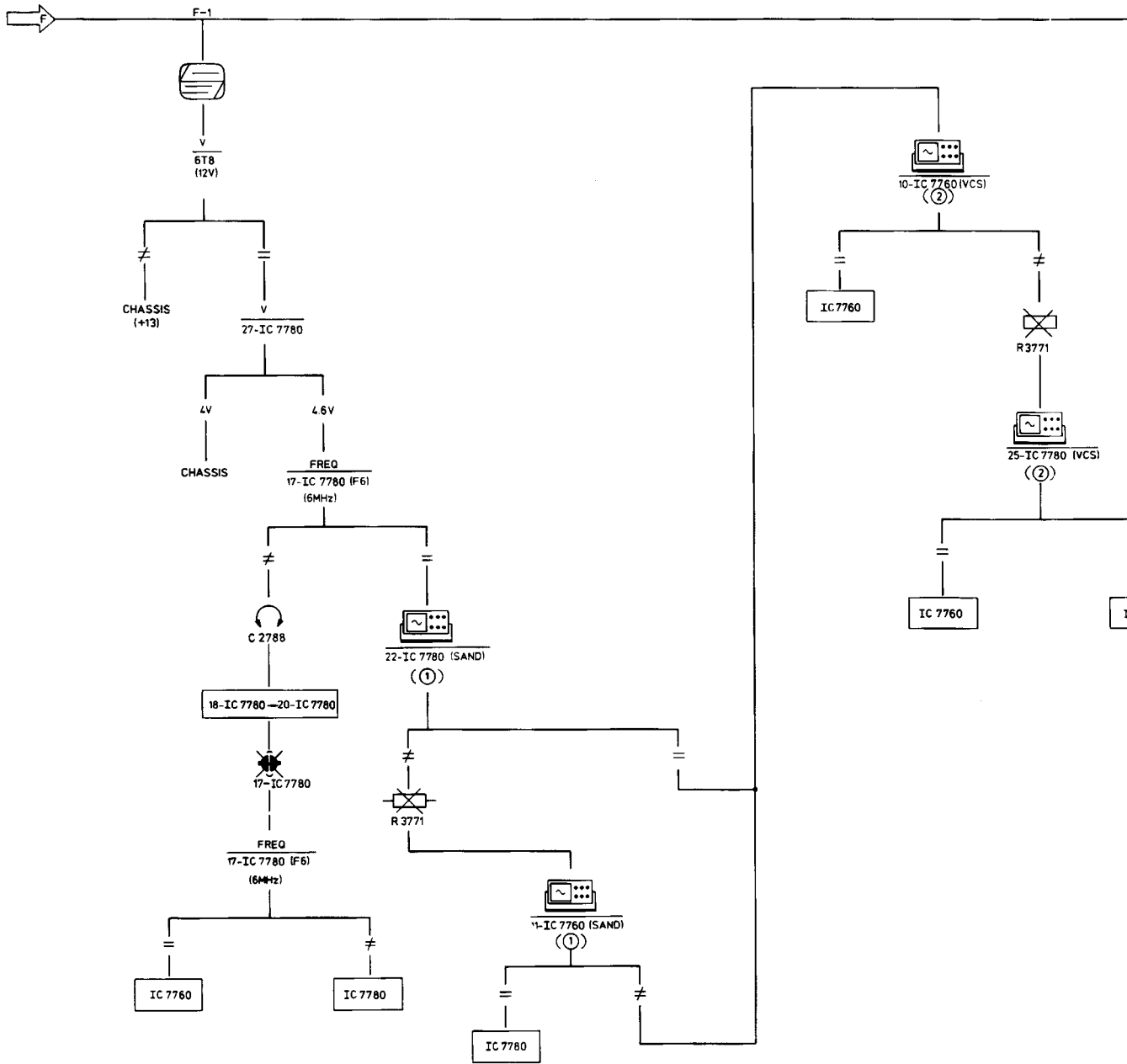

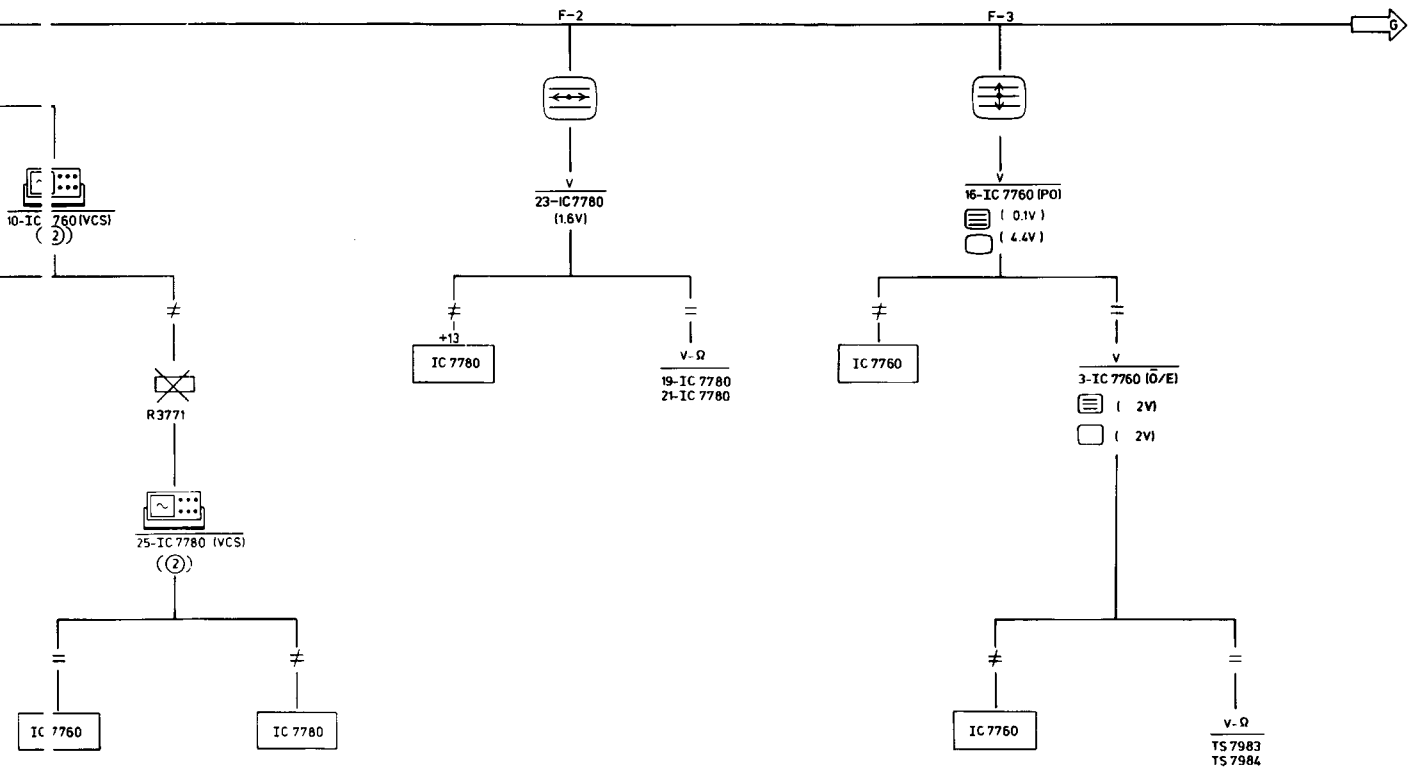

38 866 ET2

RE 'AIR METHOD TELETEXT DECODER

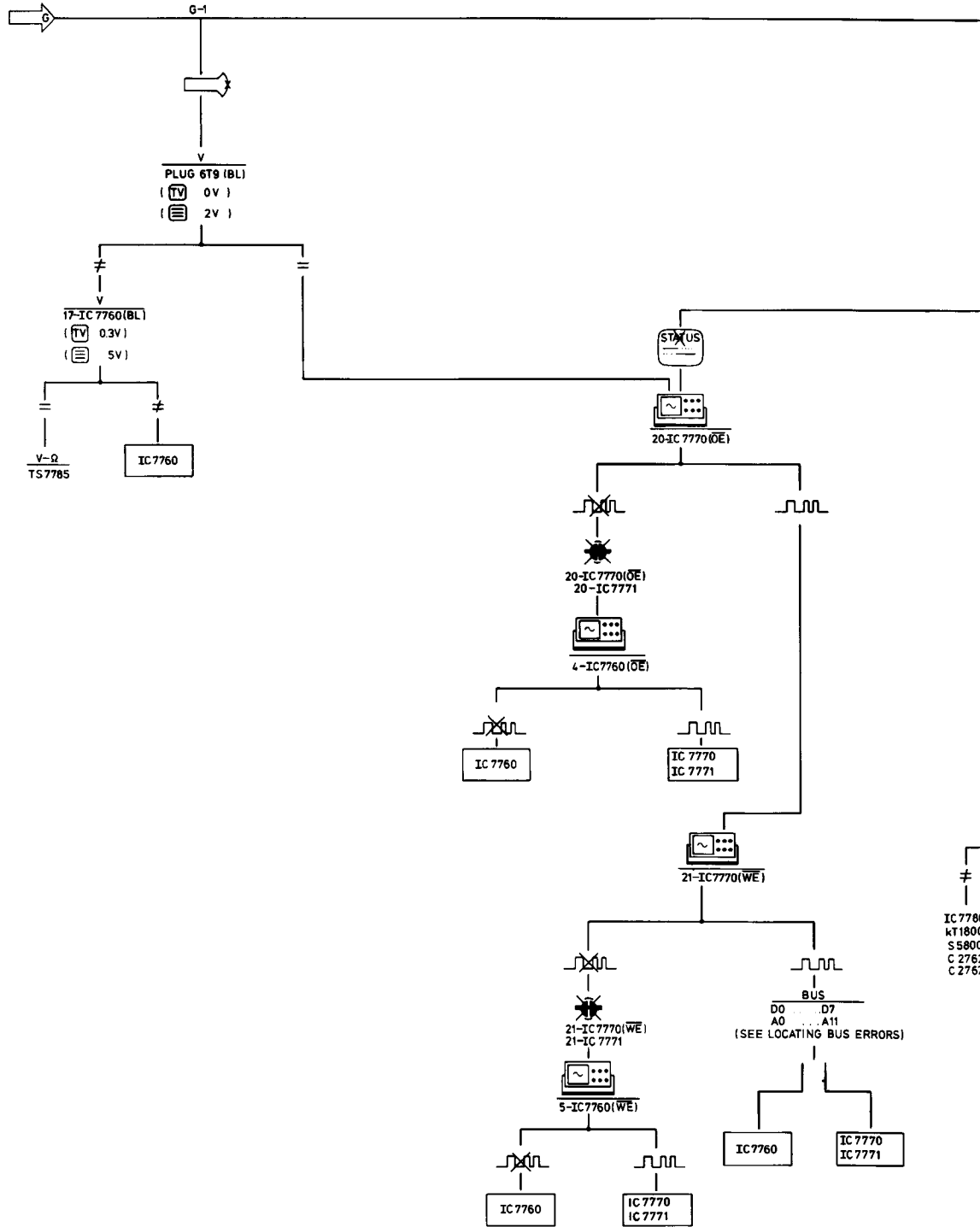

G-2

P

D.K.

* AERIAL SYSTEM
* NO TXT TRANSMISSION

STATUS

STATUS

15-IC 7780 (T D)
(3)

V-Ω
3-IC 7780
4-IC 7780
5-IC 7780
6-IC 7780
8-IC 7780
9-IC 7780
11-IC 7780
12-IC 7780

IC 7780

14-IC 7780 (TTC)
(4)

IC 7780
KT 1800
S 5800
C 2762
C 2767

IC 7780

IC 7760

11-IC 7780 (13.875 MHz) (6)
12-IC 7780 (6.9 MHz) (5)

IC 7780

IC 7760

IC 7780
KT 1800
S 5800
C 2762
C 2767

14-IC 7780

14-IC 7780 (TTC)
(5)

IC 7780

IC 7760

07
A11
BUS ERRORS)

IC 7770
IC 7771

REPAIR METHOD TELETEXT DECODER

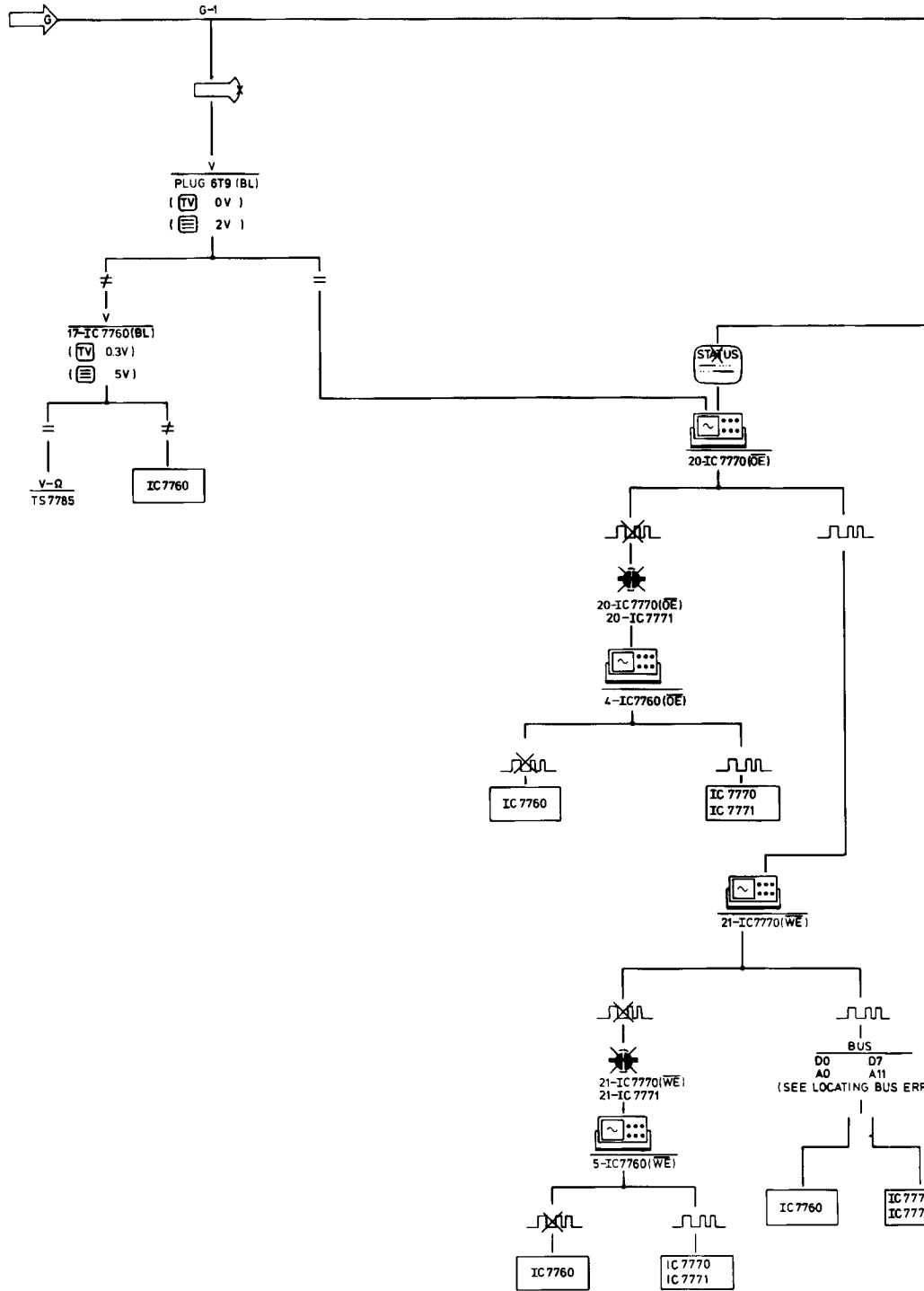

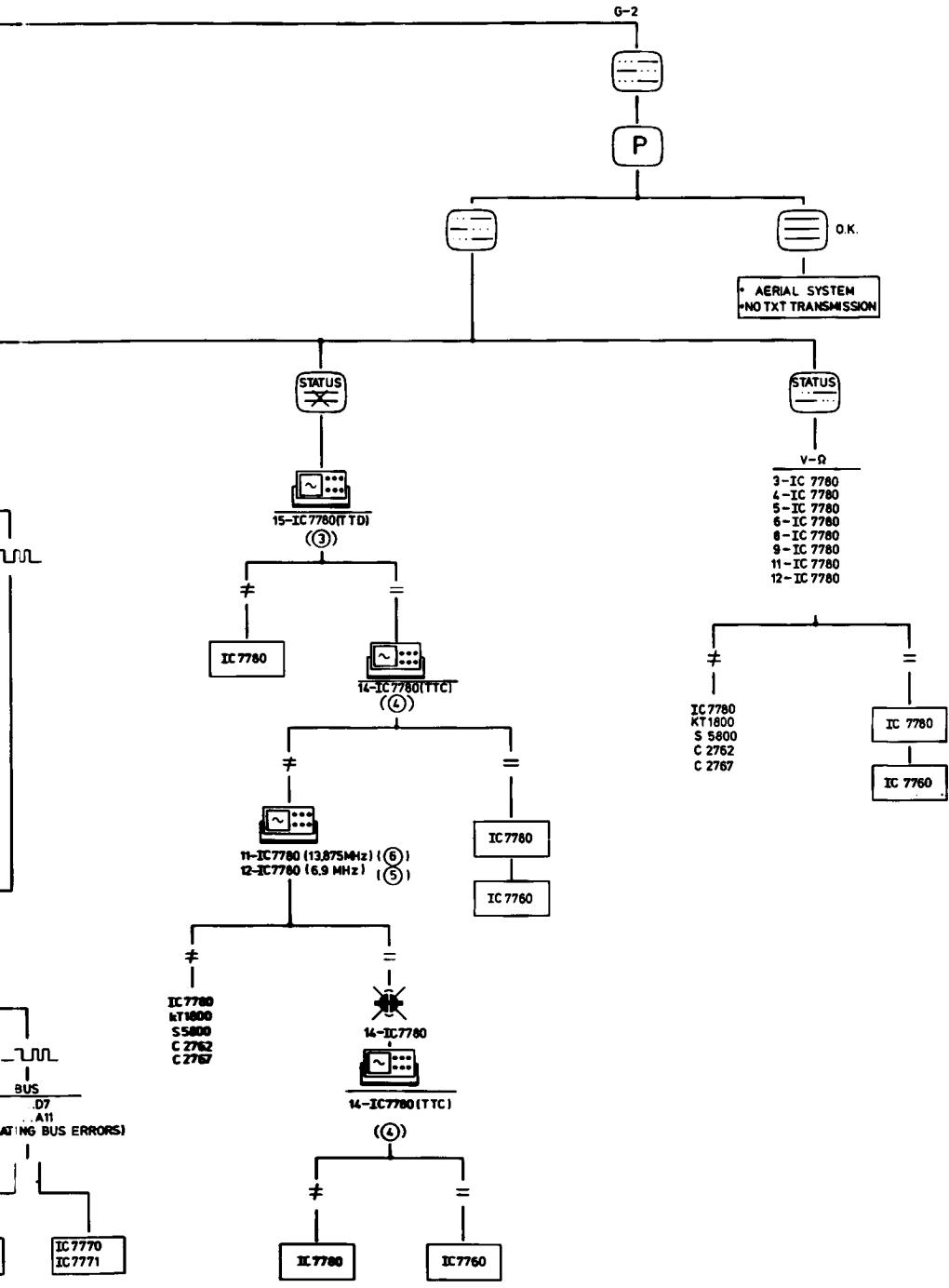

LOCATING BUS ERRORS IN THE TELETEXT DECODER

- Loosen one side of resistor 3785 on the teletext decoder.
Connect a piece of wire with measuring-pin to point 6 of socket T9.
- Connect a TV pattern generator (i.e. PM5519) and tune the receiver normally.
Apply a white pattern and select the teletext mode with the remote control.

- When transferring the measuring-pin to the points of IC7760 which are indicated under the pictures below a defined pattern will be displayed on the screen.
If the pattern is not present, but a uniform white or dark picture arises, there is question of short-circuit or an open connection on the relevant point. It may be caused by one of the three ICs, namely IC7760 - IC7770 - IC7771.

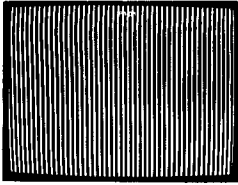

OE 4-IC7760

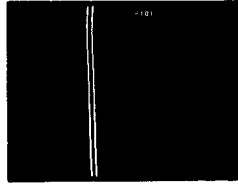

WE 5-IC7760

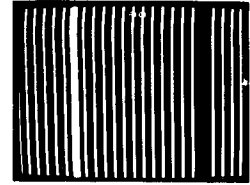

A0 30-IC7760

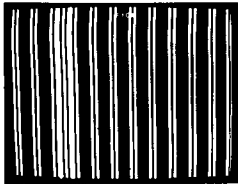

A1 31-IC7760

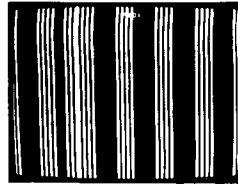

A2 32-IC7760

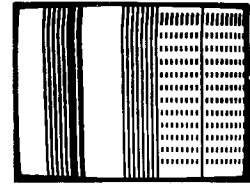

A3 33-IC7760

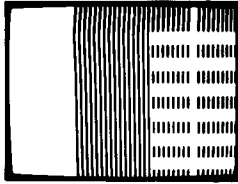

A4 34-IC7760

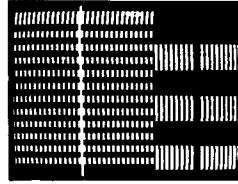

A5 35-IC7760

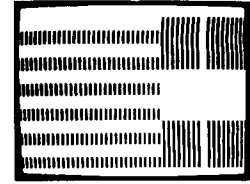

A6 36-IC7760

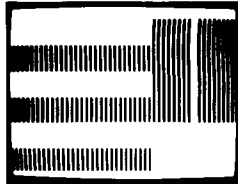

A7 37-IC7760

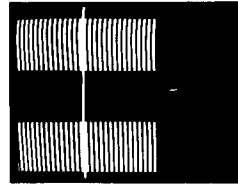

A8 38-IC7760

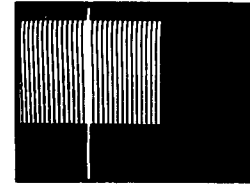

A9 39-IC7760

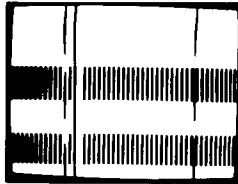

A10 40-IC7760

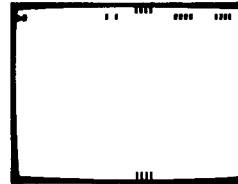

D0 22-IC7760

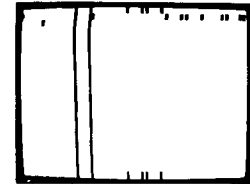

D1 23-IC7760

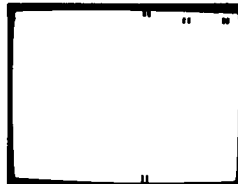

D2 24-IC7760

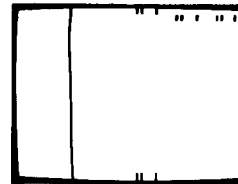

D3 25-IC7760

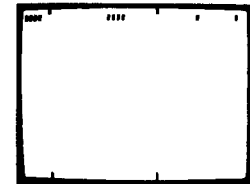

D4 26-IC7760

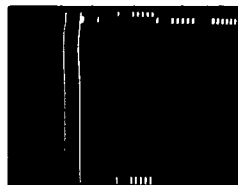

D5 27-IC7760

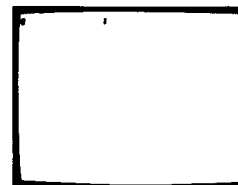

D6 28-IC7760

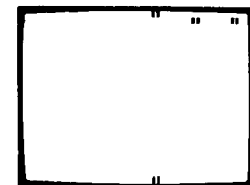

D7 29-IC7760

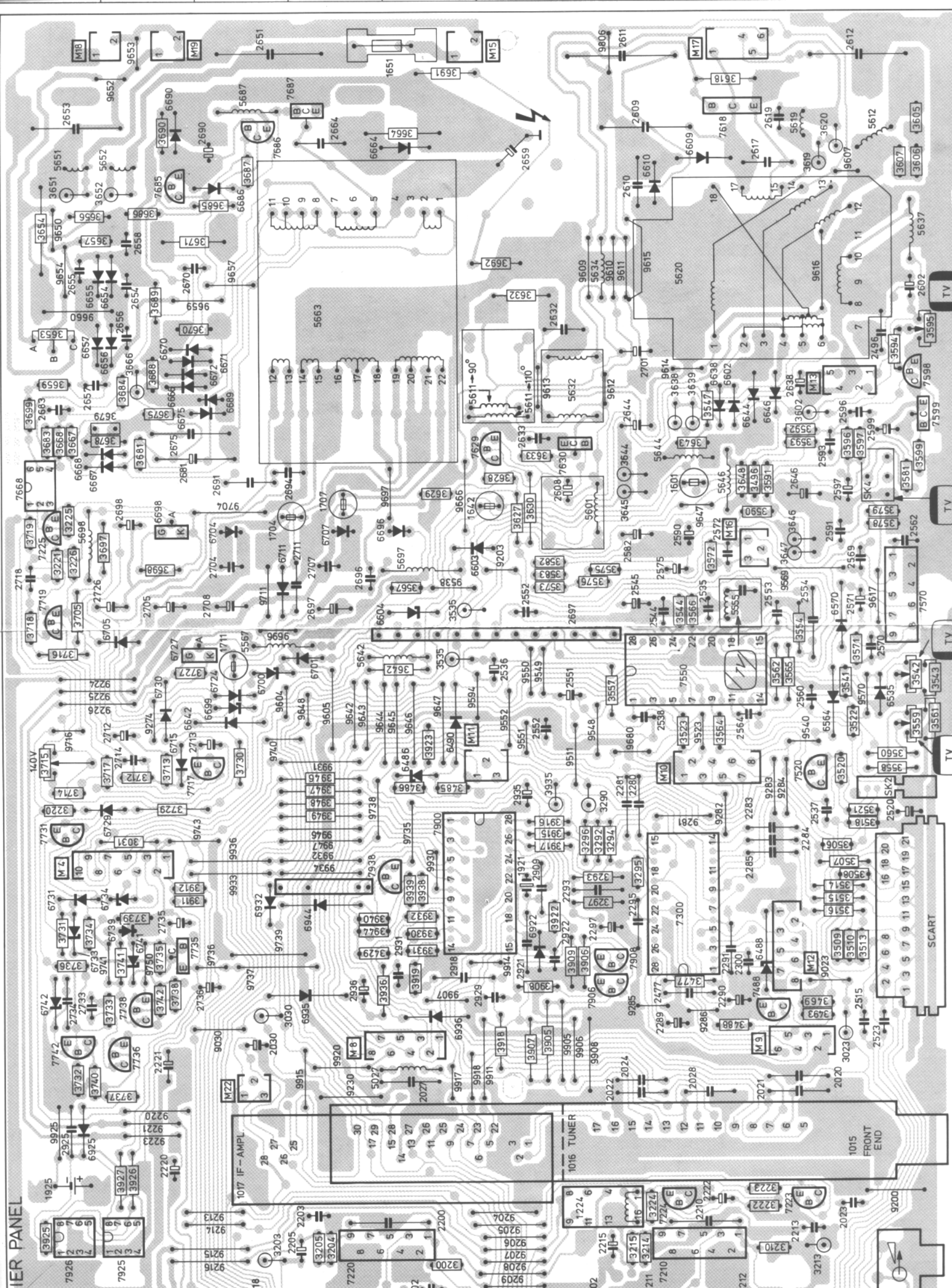

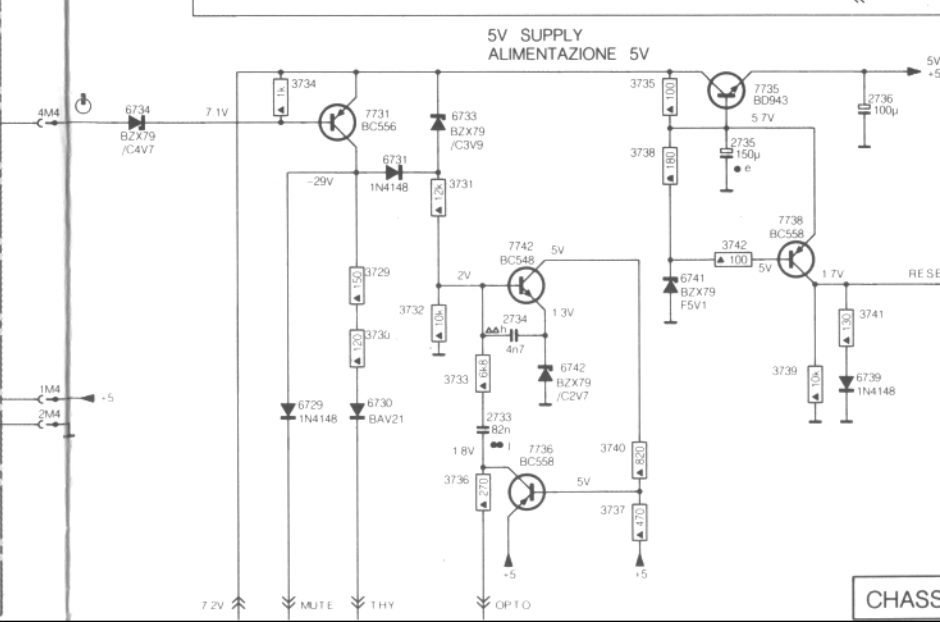
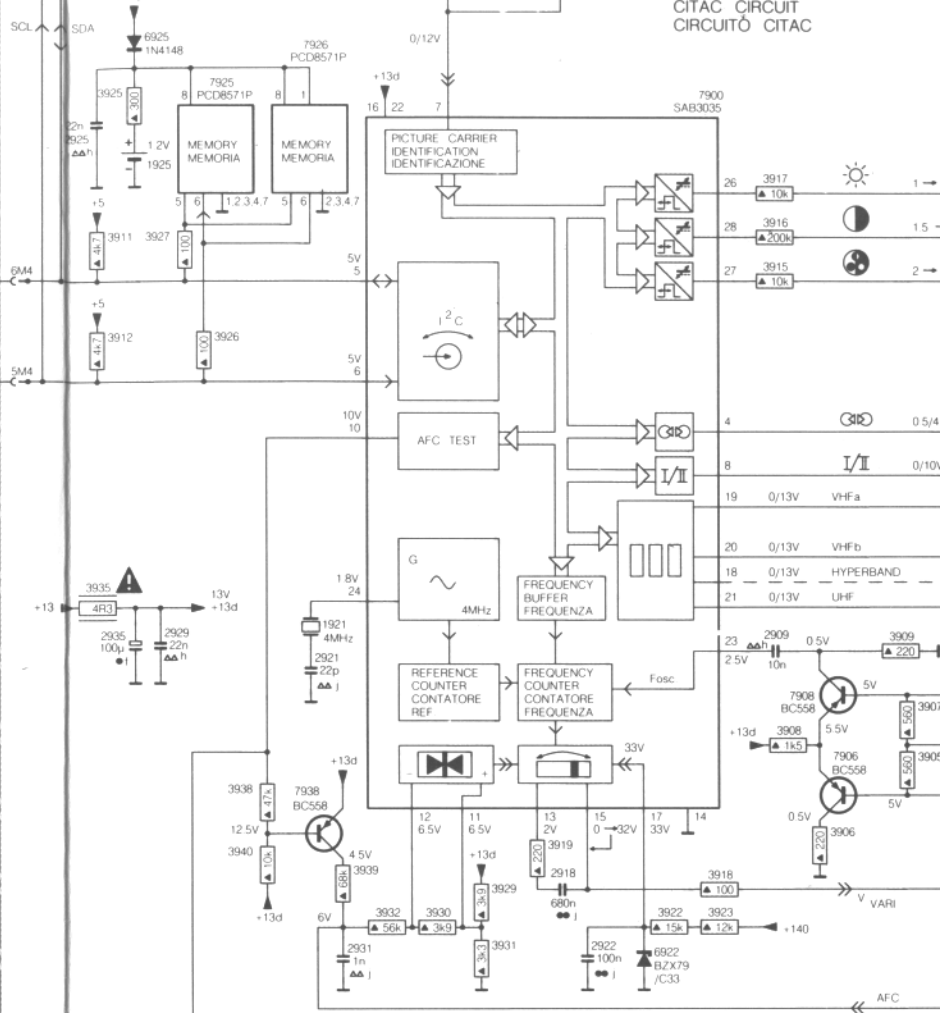
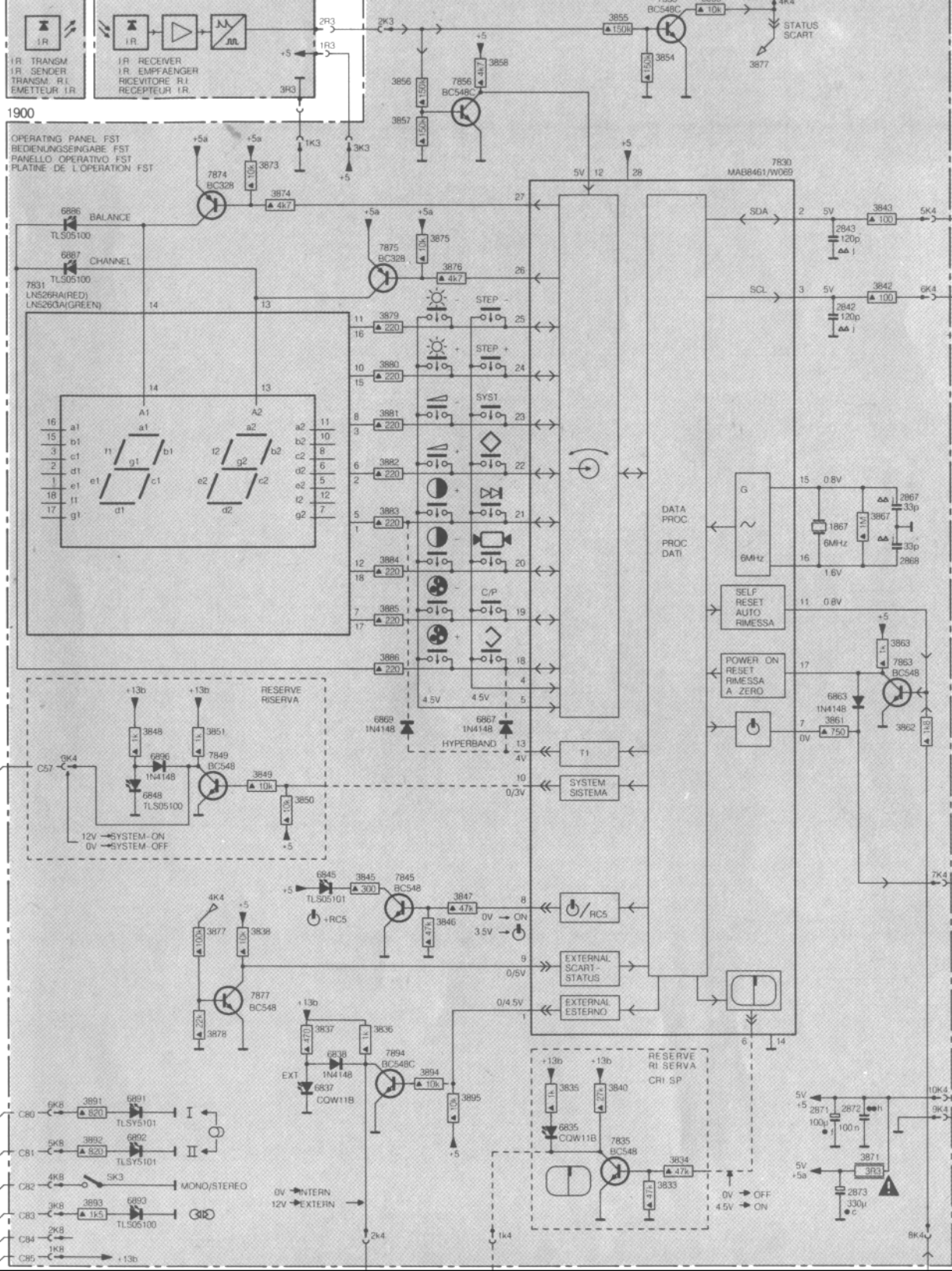

CHASS

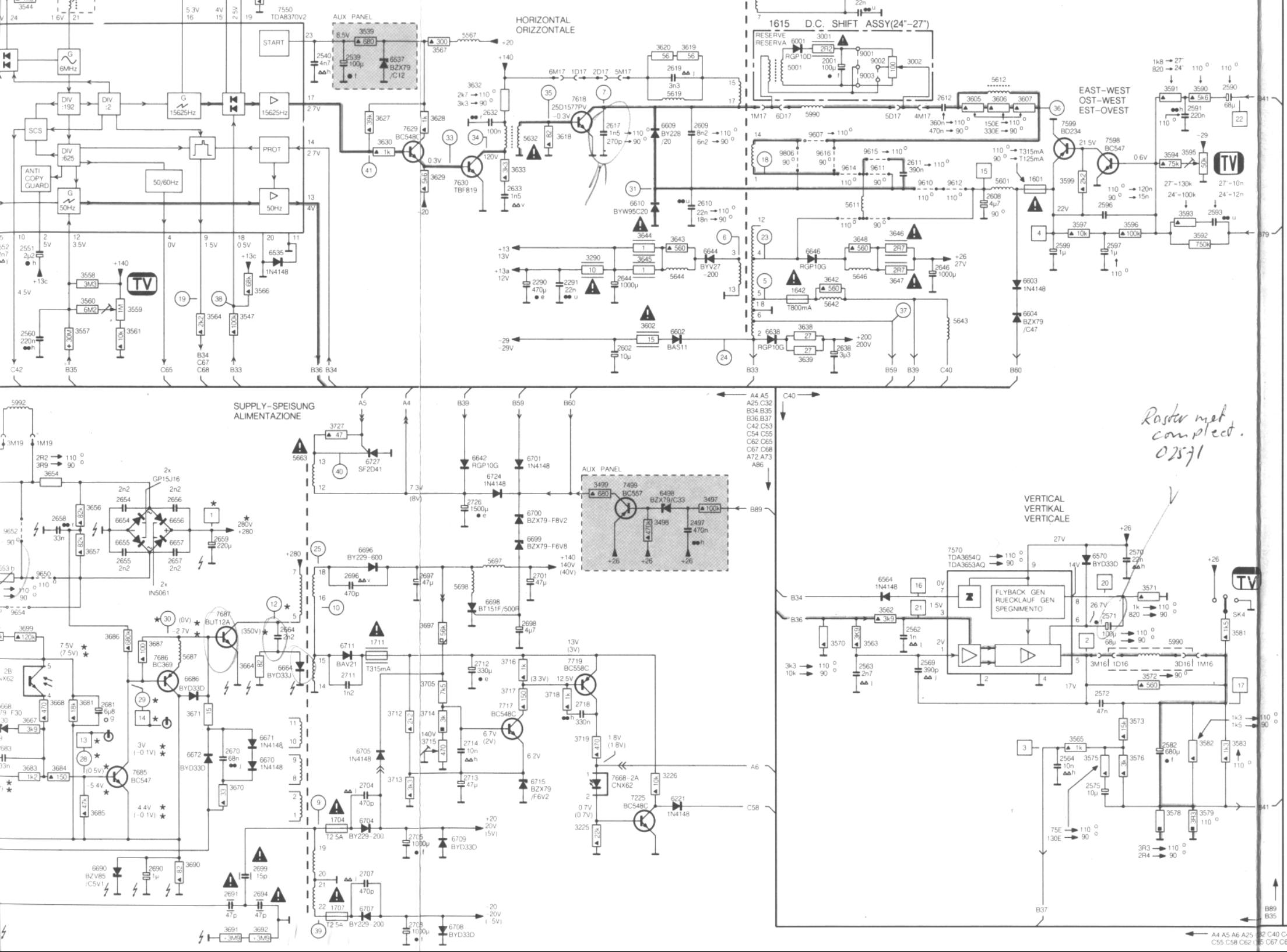

1400 PICTURE TUBE PANEL

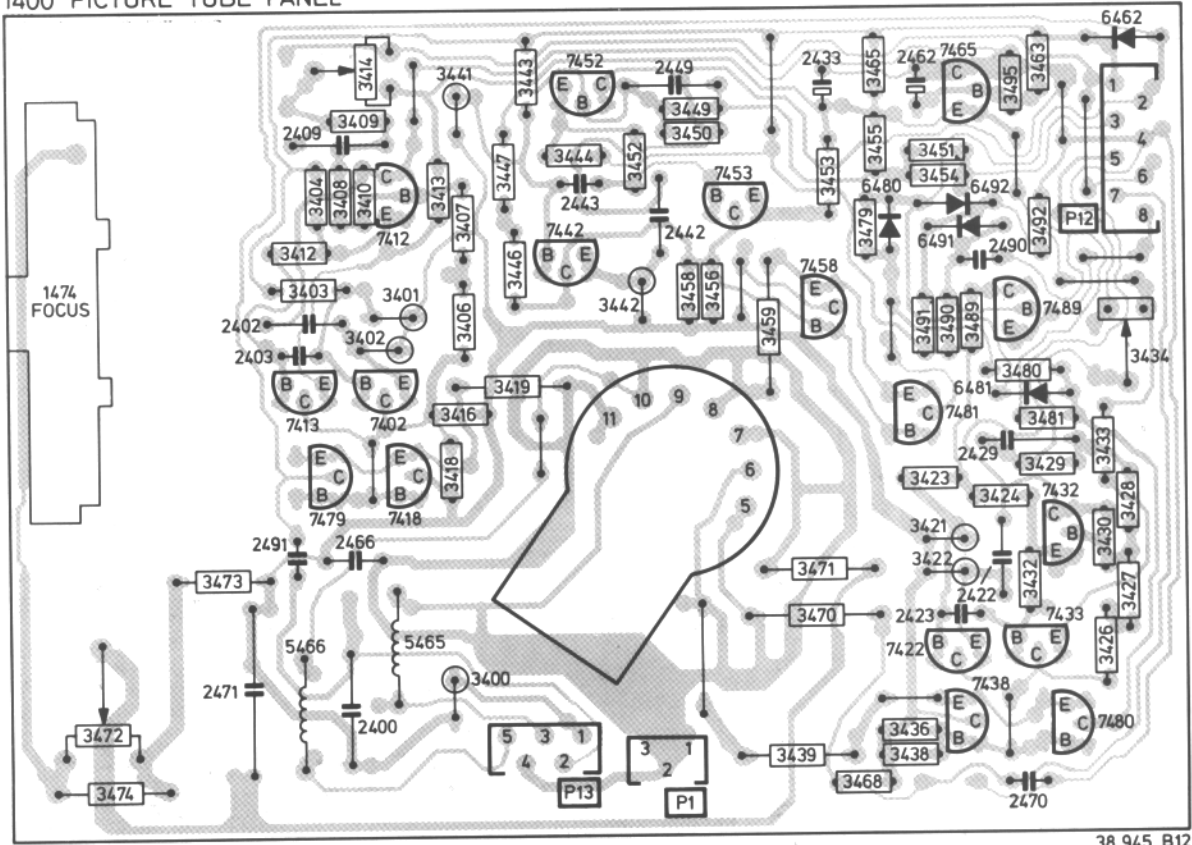

38 945 B12/619

AUXILIARY PANEL NEAR SYNC. IC 4822 212 22529

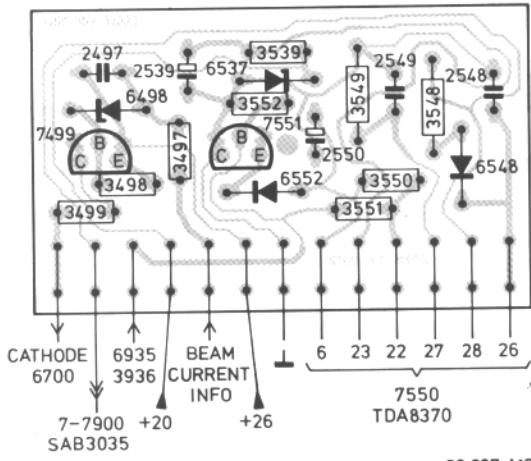

39 397 A12

1250 HEADPHONE PANEL

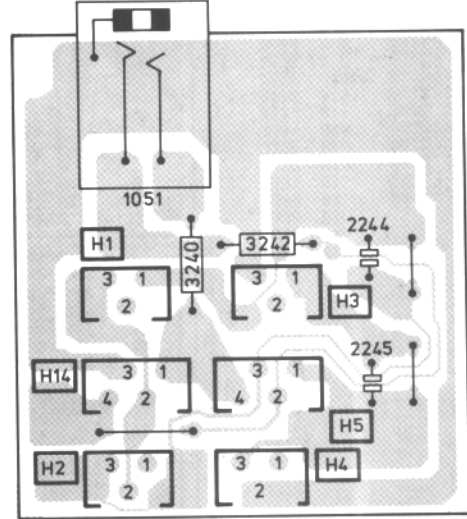

38 942 A7 (619)

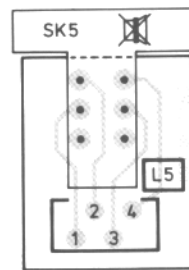

38941 A7 (619)